

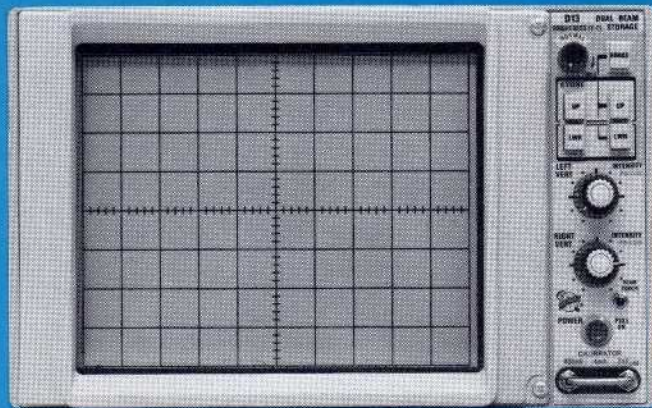

TEKSCOPE

MARCH 1971

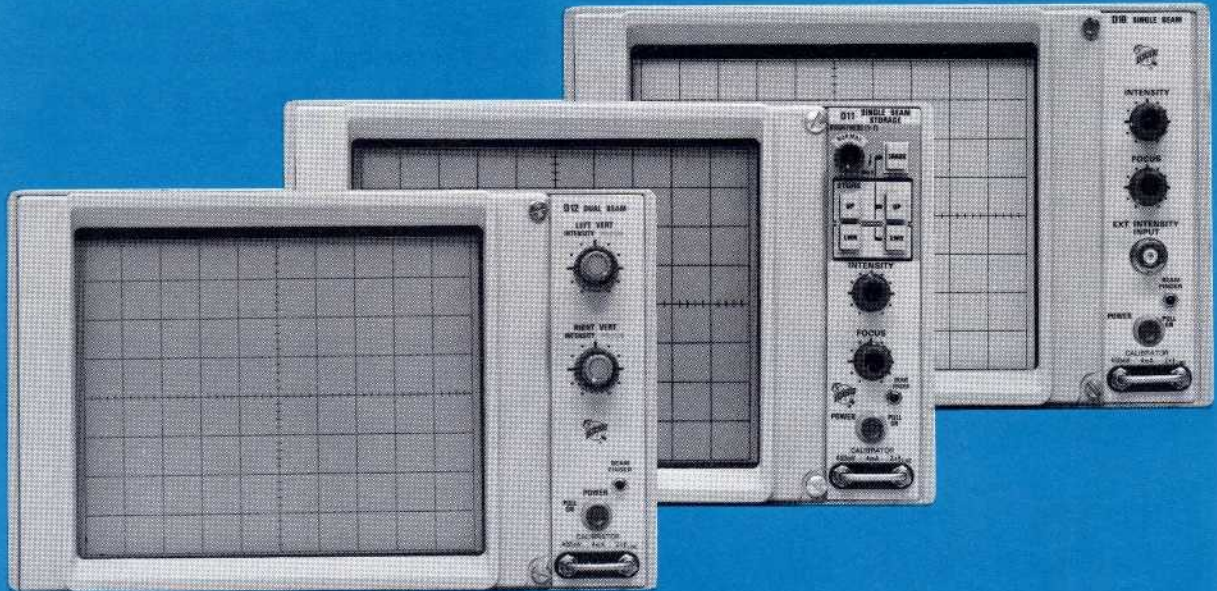

The low-frequency oscilloscope goes plug in

Signal generation and conditioning with a new modular system

Measuring the linearity of fast ramps

Servicing the 7704 high-efficiency power supply

THE LOW-FREQUENCY OSCILLOSCOPE GOES PLUG-IN

Gary Vance, Project Engineer and George Hull, Design Engineer on the 5100 Series discuss sweep-switching operation of the 5B12N Dual Time Base Plug-In.

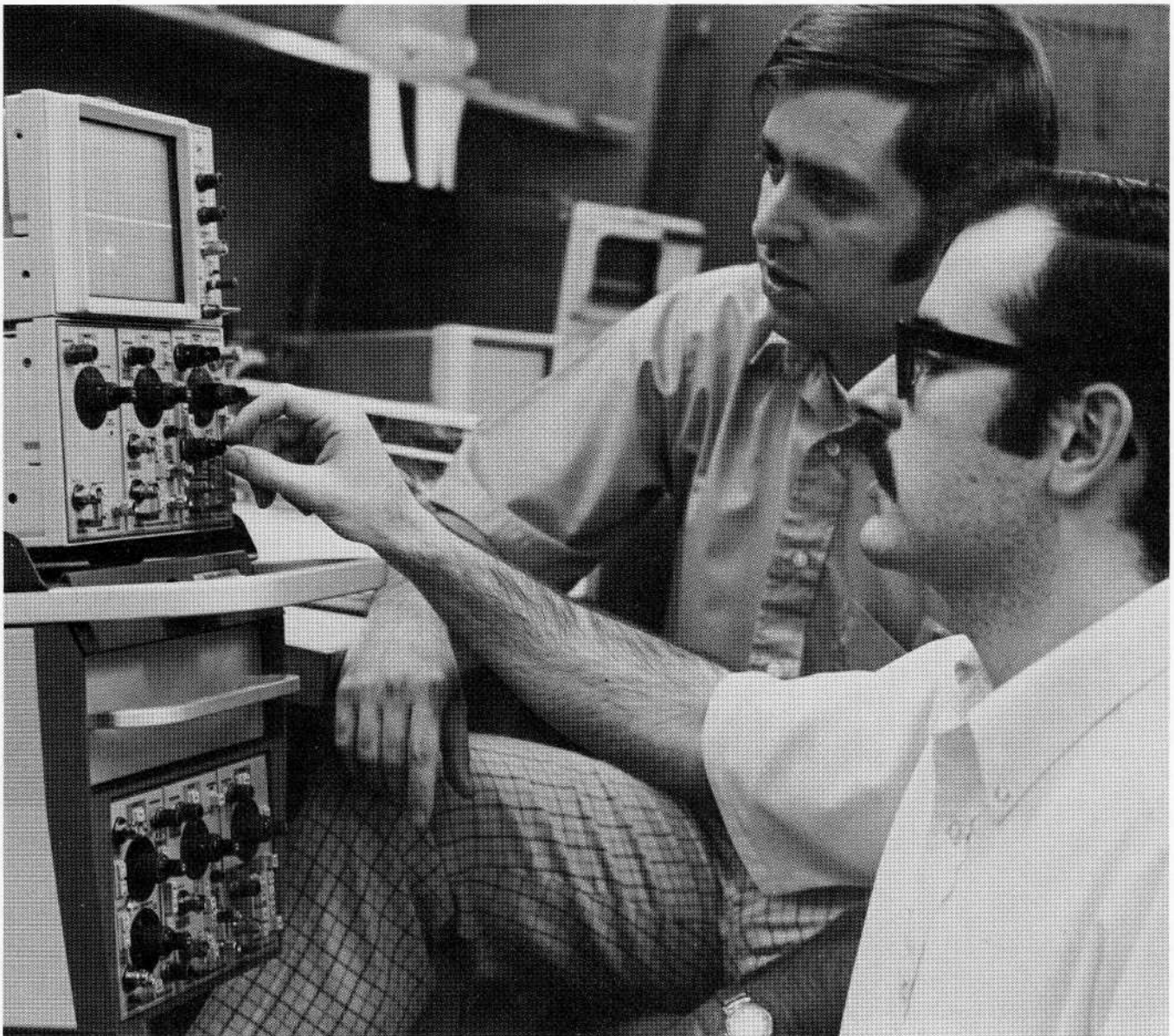

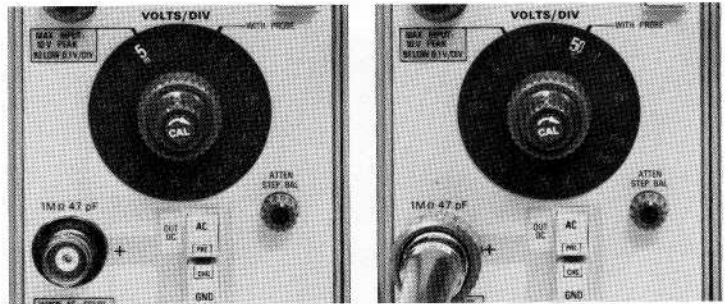

Scale factor readout changes automatically to indicate vertical sensitivity at probe tip when recommended 10X probe is used. Similarly, sweep-rate readout changes automatically when 10X magnifier is turned on.

By Jerry Shannon and Ahne Oosterhof

In the oscilloscope field, plug-in versatility has traditionally been limited to high-frequency instruments. Introduced by Tektronix in 1954, the plug-in concept allowed the user to easily and inexpensively change the characteristics of his oscilloscope to cover a wide range of applications.

Now, with the introduction of the 5100 Series, the users of low-frequency oscilloscopes will enjoy these same benefits.

Since the same need for versatility exists in the low-frequency as in the high-frequency oscilloscope field, we determined to do our best to meet that need. Our goal was to offer a laboratory-quality, low-frequency, plug-in oscilloscope at the lowest practical cost to the user. We also wanted to include many of the features such as scale factor readout, large screen CRT and solid state stability found only in the latest instruments.

Breakthroughs would have to be made in many areas. Simplified circuit design, new production techniques for CRT's, switches and other components, and reduced assembly and calibration time would have to be achieved if we were to reach our goal. The end result of our efforts in all of these areas is a series of products that bring you new measurement capability, plus a flexibility previously unavailable in any other oscilloscope system.

First in this series is the 5103N Oscilloscope System, a general-purpose, low-frequency (DC to 2 MHz) oscilloscope featuring cost-saving innovations such as interchangeable display modules, plug-ins, and bench to rackmount convertibility. Four display modules, each with a large 6½-inch CRT, give you a choice of single beam, dual beam, single beam storage or dual beam storage. You can readily change from one display module to another or convert from bench to 5¼-inch rackmount configuration in a matter of minutes. Nine plug-ins give you a wide choice of vertical amplifiers and time bases.

Several innovations in the amplifier and time base plug-ins enhance operating ease. For example, scale factor readout for each amplifier is provided by illuminating the knob skirt behind the area identifying the correct scale factor, even when using the recommended 10X probes. This same feature is used in the time base plug-ins to indicate correct sweep rate with the magnifier on or off. The possibility of measurement error is thus greatly reduced.

The choice between left and right vertical plug-in is made by depressing the DISPLAY button on the respective plug-in. This button also switches the light on behind the readout skirt, so a glance is all that's needed to immediately identify which channels or plug-ins are in use. With neither DISPLAY button depressed, the left hand vertical is displayed but its readout is not illuminated.

When two amplifier plug-ins are enabled, the mainframe automatically converts to the alternate or chopped mode of operation as selected by the DISPLAY button on the time base. The switching sequence allots two time-slots (in chopped) or two sweeps (in alternate) to each vertical plug-in. When dual-channel plug-ins are used, each channel takes one time slot or one sweep. In the dual-beam mainframe, switching between plug-ins is eliminated as each amplifier is permanently connected to one vertical deflection system.

THE MAINFRAME

Now let's take a closer look at each of the 5100 Series modules. The 5103N mainframe module contains the low-voltage power supplies, horizontal and vertical amplifiers, the electronic switching and logic circuitry for dual-trace operation between plug-ins, and three plug-in compartments. It will interface directly with any of the four display modules in a bench or rackmount configuration. Any plug-in can be used in any compartment to achieve X-Y, Y-T or raster displays.

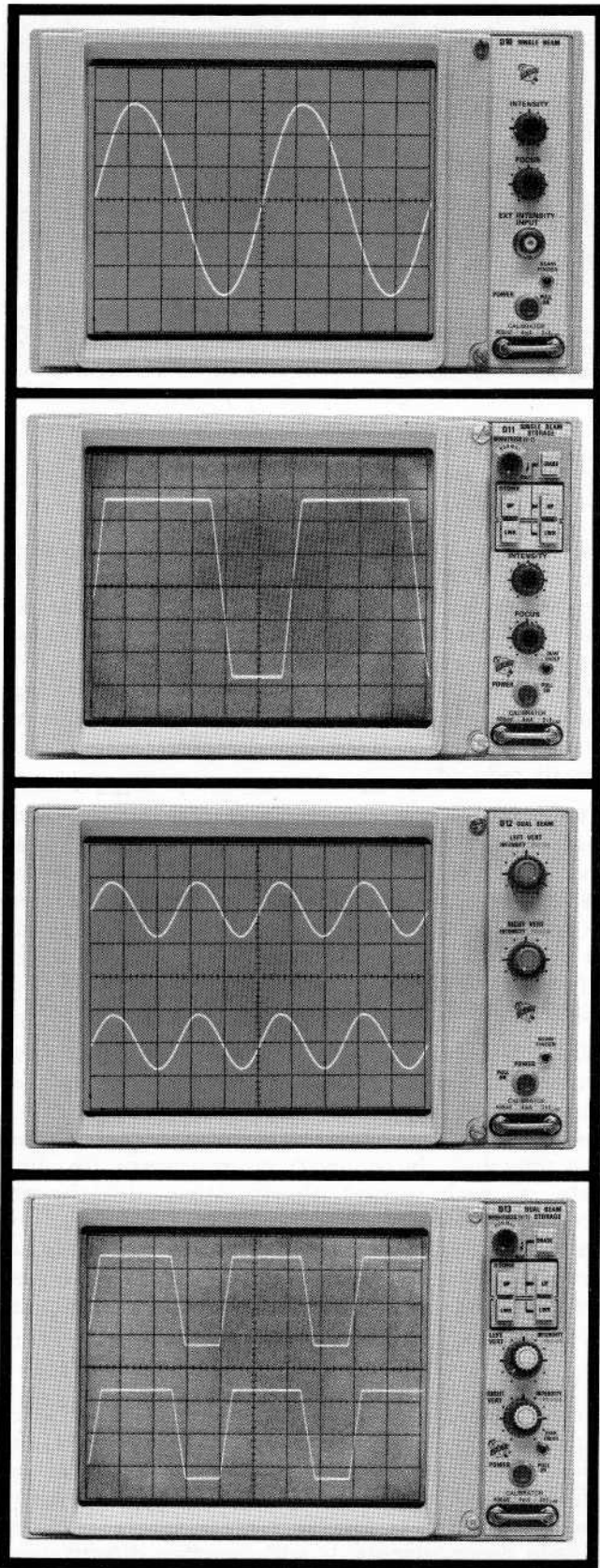

Four display modules pictured from top to bottom are single beam, single beam storage, dual beam and dual beam storage. All feature a large 6 1/4" screen and internal graticule.

THE DISPLAY MODULES

Each of the display modules uses a new 6 1/2-inch ceramic CRT with an 8 x 10 division (1/2 inch/div) internal graticule. The CRT, with 3.5 kV accelerating potential, has a bright, well-defined trace. Simplest of the display modules is the D10 single-beam display unit. In addition to the CRT, it contains the high-voltage supply, a voltage, current and time (2X line frequency) calibrator, the CRT controls and the power switch. A beam finder positions the beam on screen regardless of the setting of the vertical or horizontal position controls. The front panel Z-axis input with DC to 1-MHz bandwidth requires only 5 volts to modulate the beam.

The D12 dual-beam display module is the same as the D10 single-beam unit except the CRT has two writing guns and two pairs of vertical deflection plates. Both beams cover the full 8 x 10 division screen. Also included are separate intensity and focus controls for each beam.

Single and dual-beam storage operation are provided by the D11 and D13 display modules respectively. The bistable, split-screen storage CRT's have a unique brightness control which permits varying the stored brightness to retain the image for several hours without damage to the CRT. The brightness control, in conjunction with other storage controls, also allows integration of repetitive signals to effectively increase stored writing rate.

THE PLUG-INS

The nine plug-ins presently available include six amplifiers and three time bases. Simplest of the amplifiers is a plug-in having just an input stage with a potentiometer as an attenuator. Designated the 5A24N, the unit has a 50 mV/div sensitivity and is ideal for you who have low-cost monitor needs.

For simple measurements where signals of varying amplitude have to be measured, the 5A23N with decade attenuator steps and a 10 mV sensitivity is available. Bandwidth is DC to 1 MHz.

A companion plug-in, the 5B13N time base, provides a low cost sweep unit with sweep ranges from 5 μ s/div to 0.5 sec/div in decade steps. A variable control extends the slowest sweep to 5 sec/div.

When signals of only a few millivolts are to be measured, the 5A15N provides 1 mV sensitivity and DC to 2-MHz bandwidth. The 5A18N offers the same characteristics with dual-trace capability including the convenient ADD mode. This mode is especially useful when signal differences between two points are to be measured while both points are elevated by a common signal.

Getting down into the difficult microvolt region where the applications call for low noise and high common-mode rejection, the 5A20N and 5A21N differential amplifiers with FET inputs provide stable operation to 50 μ V/div. Bandwidth is DC to 1 MHz. Upper bandwidth can be limited to 10 kHz for noise reduction. Common-mode rejection at 50 μ V/div, DC coupled, is 100,000:1.

To permit common-mode measurements with the use of attenuator probes, a probe having accurate attenuation has been developed. The P6060 has 10X attenuation and provides common-mode rejection of 400:1 at any deflection factor when used with the 5A20N or 5A21N.

The 5A21N plug-in, while similar to the 5A20N, has the added feature of a current-probe input. Using the P6021 current probe, bandwidth is 15 Hz to 1 MHz with sensitivities from 0.5 mA/div to 0.5 A/div. The normal 100 Hz low-frequency response of the P6021 is extended by low-frequency correction in the amplifier to permit measurements at line frequency. This makes the unit especially useful in power supply design work.

Many low-frequency applications make use of X-Y type displays. As the mainframe has identical vertical and horizontal deflection systems it is possible to make accurate phase measurements using two identical plug-ins. A control on the deflection amplifier board allows phase calibration to better than one degree at specific frequencies up to 1 MHz.

Two more time bases round out the selection of plug-ins available. The 5B10N provides sweep ranges from

1 μ s/div to 5 sec/div in a 1-2-5 sequence with a 10X magnifier extending the fastest sweep to 100 ns/div. The unit offers versatile triggering from DC to 2 MHz. Both trigger source and trigger mode are selected by pushbutton. A single-sweep mode simplifies the capturing of single-shot phenomena for photographing or storing displays. Included is an external horizontal mode which provides a convenient means for making simple X-Y measurements. Sensitivity is 50 mV/div with DC to 1-MHz bandwidth.

A dual time base, the 5B12N, covers a wide range of applications. Offering the maximum in versatility, it includes the popular sweep switching introduced in the 547 Oscilloscope. In the dual-sweep mode, the A sweep is slaved to the left plug-in, and the B sweep is slaved to the right plug-in. This gives you, in effect, dual-beam operation for repetitive signals. The two sweeps can also be operated in the conventional delaying-sweep modes with a 10-turn delay multiplier providing accurate delay settings. The 5B12N also includes an external horizontal mode for X-Y operation.

Some applications require a vertical sweep or raster presentation. This is easily accomplished by plugging any of the three time bases into one of the vertical compartments. The 5103N provides convenient front panel access for Z-axis modulation in these applications.

A low-cost camera, the C-5, complements the low-frequency 5100-Series instruments. Its fixed-focus, fixed-aperture design makes waveform photography simple. An access door in the top of the camera allows viewing the CRT without removing the camera.

Some of the areas expected to benefit from the versatility of the 5100 Series are medical research, educational instruction, low-frequency phase work such as servos, mechanical analysis using strain gauges and other transducers, and engine analysis.

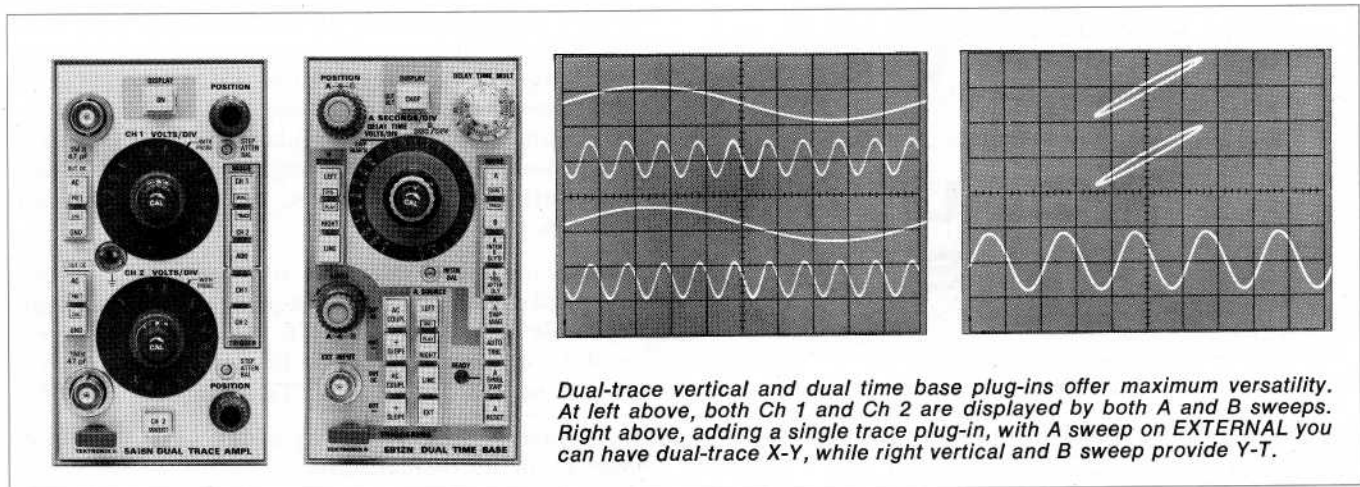

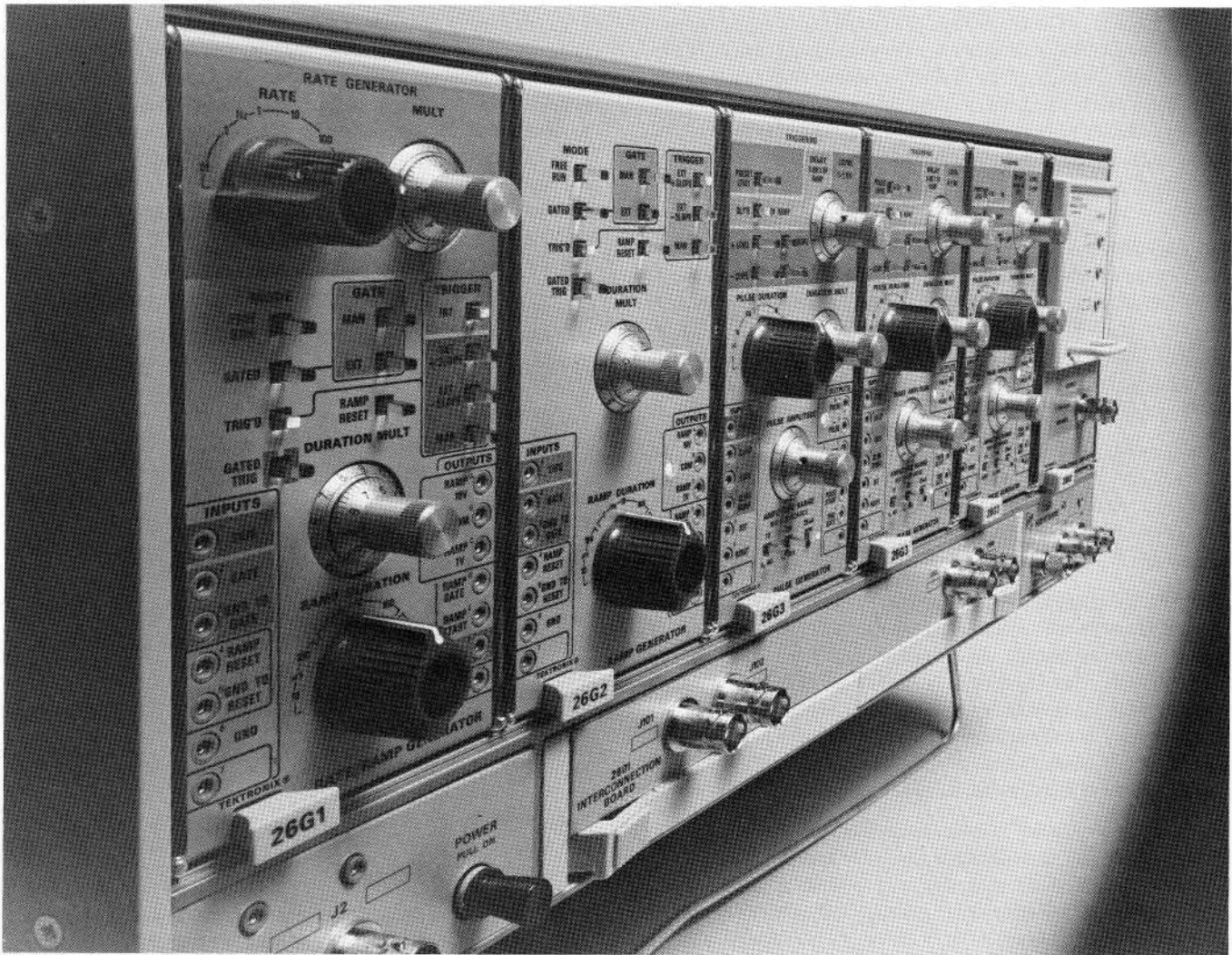

SIGNAL GENERATION & CONDITIONING

WITH A NEW MODULAR SYSTEM

Plug-in versatility has proven its worth in oscilloscopes, counters, pulse generators and myriad other products. Now this concept is extended to a new series of instruments designed to be the meeting place for many different systems. We call them the 2600-Series modular instruments. The term "modular" is used here in a broad sense and includes packaging, interconnections, input/output characteristics, power supplies and accessories.

Designed to permit relatively free interplay between analog and digital circuits, most inputs and outputs are compatible with DTL and TTL logic levels. However, they differ electrically slightly to allow proper operation with non-DTL and non-TTL circuits.

To get a feel for the versatility of the series, let's look briefly at the individual units.



Digitally signed by
<http://www.aa4df.com>

2601 MAINFRAME

The 2601 mainframe, a basic element in the series, is a power supply and interconnecting system for 2600-Series plug-in units. Providing pre-regulated voltages at up to 50 watts, the 2601 accommodates six plug-in units. The pre-regulated voltages are further regulated in the individual plug-ins and, in some instances, used to power DC to DC converters for special needs. This provides maximum decoupling between units.

A seventh plug-in section in the 2601 plays a vital role in the versatility offered by the 2600 Series. It contains the interconnection board. The primary function of this board is controlling plug-in unit operation, processing signals to or from a plug-in, or passing signals between units. Thus, having planned and set up system operation from the front panel, you can duplicate the connections between units on the interconnection board and then tuck them away out of sight. Spare boards may be used to change rapidly from one setup to another. Most plug-in front panel inputs and outputs are coupled through the interface connections at the rear of the plug-ins and are duplicated on the interconnection board.

Pictured below are two of the interconnection boards currently available. The board on the left is used primarily to provide interconnection between plug-ins.

The board on the right also provides interconnection between plug-in units but has an exciting additional feature. Fourteen 16-pin dual in-line plastic I.C. sockets, plus a locally regulated +5 volt supply, are mounted on the board. Ready connection between I.C.'s and the plug-in units is made by standard 40-mil patch connectors. This permits you to add the relays, switches, pulse transformers, resistor networks, op amps and many other functions available in the dual in-line package, to the functions available in the 2600-Series plug-ins. Instrument versatility thus becomes virtually unlimited.

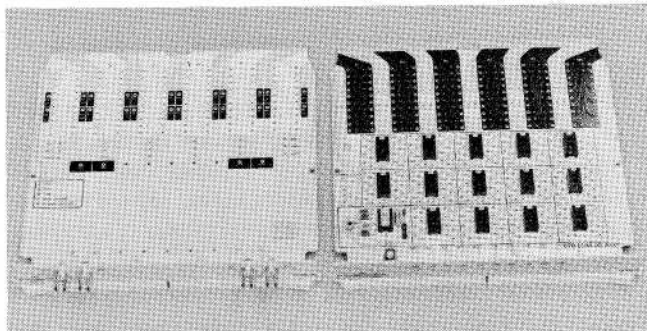

Interconnection board at left permits internal connection between plug-ins. Board at right interfaces plug-ins with 14 IC sockets. Board includes +5 V regulated supply to power IC's.

You may also elect to use the I.C. board and 2601 mainframe plug-ins completely independent of one another. Ten spare front panel jacks on the interconnection board provide convenient interface points. Front and rear panel BNC connectors on the 2601 may also be connected internally to any jack on the I.C. interconnection board. The pre-regulated +17 and -17 volt supplies are available on the board and can often be used to power linear I.C.'s where other than +5 volts is required.

RATE AND RAMP GENERATORS

Now let's take a look at the plug-ins. The 26G1 and 26G2 are basically ramp generators and produce ramp voltages ideal for analog timing applications such as delayed triggering of pulse generators, time bases for monitors, and raster generation.

Several ramp modes are available to you. Free run, gated, triggered, and gated trigger, plus manually gated or triggered operation is readily accomplished from the front panel. In addition, the 26G1 can be internally triggered by the rate generator which is an integral part of the unit. The trigger and gate levels, both input and output, are compatible with logic levels used in most DTL and TTL logic devices.

A convenient feature is the ability to terminate the ramp at any point in its excursion by applying a positive logic 1 to the Ramp Reset input or a logic 0 to the Ground to Reset input. This provides for some interesting possibilities. For example, the 26G1 or 26G2 can serve as a time-to-height converter. The amplitude of the ramp output can be made proportional to the input pulse width simply by feeding the pulse into both the Trig and Ground to Reset inputs. The ramp is then started by the leading edge of the pulse and terminated when the pulse falls to zero.

In addition to the main ramp output of 10 volts, several other signals are available at the front panel. A 1-volt ramp output serves as a convenient time base for the 601, 602 and 611 monitors which are ideal companion units to the 2600 Series. The +3-volt Ramp Gate, of the same duration as the ramp, provides unblanking for the monitor. A +3-volt, 1.5- μ s pulse coincident with the start of the ramp is handy to trigger your oscilloscope or other associated circuitry used in the application.

We mentioned earlier that the 26G1 also contains a rate generator. Normally free-running at a frequency determined by the Rate and Multiplier settings, it can also be gated manually or by an external gate. All that is needed is reversal of an internal 3-pin connector. The Gate and Ground to Gate inputs then serve to gate the rate generator, with the first pulse from the rate generator coincident with the start of the gate. The rate generator may be used independent of the ramp generator portion of the 26G1.

PULSE GENERATION

The 26G3 Pulse Generator plug-in unit provides precise rectangular pulses with amplitude to ± 10 volts and pulse duration from $1\mu\text{s}$ to 11 seconds. Pulse risetime and falltime is less than 200 ns. In addition, the unit has two other output modes. With the Pulse Duration control set to Bistable, the output changes state with each succeeding trigger, that is, the output goes to the high state on one trigger and to the low state on the next. A highly symmetrical waveform or pulses longer than 11 seconds can thus be easily generated.

The third mode, DC, or as it is sometimes called, "locked on", is appearing with increasing frequency on the newer pulse generators. In this mode the output is simply a DC level which can be accurately set to any value up to ± 10 volts by means of the Pulse Amplitude control. Accuracy is 1% of full scale, full scale being 1 volt, 10 volts, or a value you may choose by selecting an appropriate external resistance. Output current up to 20 mA is available to drive the selected resistance, however, maximum output voltage is limited to ± 10 volts.

Three other outputs are available on the front panel: the Pulse Start, a +3-volt pulse serving as an output trigger; the Pulse Gate, a +3-volt gate with the same duration as the pulse output; and the Trigger Gate, a +3-volt gate coincident with the start of the pulse output and whose width is determined by the Delay control setting.

Turning to the 26G3 inputs, we see a wide range of control for starting and stopping the pulse. Selection of slope and level, much the same as on your oscilloscope, is available. A preset +1-volt level is useful when triggering from logic circuits, and a ramp input provides for triggering at any point on a +10-volt ramp giving you a choice of accurate time delay before starting the pulse. The Slew Ramp input offers some interesting capabilities; a signal fed into this input is combined algebraically with the signal fed into the Ramp input to effect triggering. This gives you a convenient means of generating two pulses whose time relationship can be made to change at a controlled, linear rate.

One of the common uses of this technique is found in the field of biophysical research, the objective being to determine the ability of a nerve to respond to separate stimuli occurring within a brief time span. A look at how we can accomplish this objective using the 2600 Series will serve to demonstrate the flexibility of the system, but first let's finish our review of the 26G3 inputs.

In addition to the Trigger, Ramp and Slew Ramp inputs, there are Set and Reset inputs. A +1-volt signal to the Set input, will set the output to its high state regardless of the state of all other inputs except the Reset input. Conversely, a +1-volt signal to the Reset input will set the output to its low state regardless of the state of all other inputs including the Set input.

SYSTEM APPLICATION

Now let's look at how we can accomplish the objective mentioned above, that of determining nerve response to closely spaced stimuli, using the 2600-Series instruments. The block diagram below shows the system we can use to generate the variable-spaced pulses, including a 601 monitor to display the pulses. The system consists of the 2601 Mainframe, the 26G1 Rate/Ramp Generator, the 26G2 Ramp Generator, the 26G3 Pulse Generator and the 601 Storage Display Unit.

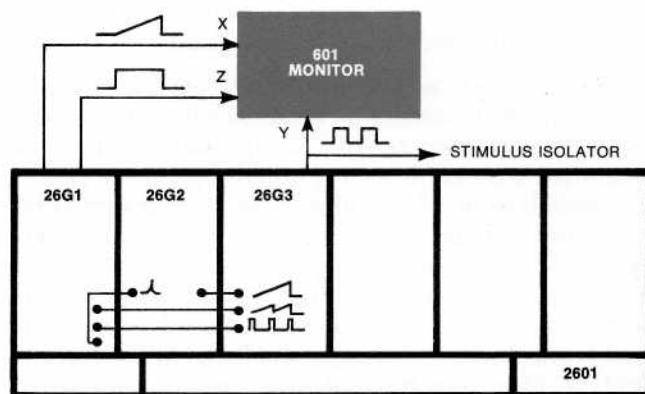

Simplified block diagram of system to produce pulse pairs having gradually reduced spacing between pulses.

Interconnection of the units and the control settings for the respective units are shown on the interconnection board worksheet at right. These worksheets are replicas of the interconnection board and provide a handy reference for repeating the set-up for a particular measurement. Replicas of the front panels of the plug-in units are available with gummed backing for pasting on the worksheet as shown. The photo in the lower right-hand corner of the worksheet shows the signal generated by the set-up.

The pulse train is initiated by pressing the Manual button on the 26G2. The 26G2 performs four functions. It starts the pulse train, gates the 26G1, provides the slew ramp for the 26G3 and determines the total period over which the nerve will be exercised, in this instance, 10 seconds.

The 26G1 also performs four functions. It determines how often the 26G3 generates pulse pairs, provides the ramp input for the 26G3, determines, in conjunction with the slew ramp and the Delay control setting on the 26G3, when a stimulus pulse will be generated, and provides the sweep and unblanking signals for the 601 monitor.

The 26G3 merely stands by and generates a pulse of the appropriate duration and amplitude when its triggering level is reached.

Now let's see what happens when we push the Manual button on the 26G2. A single pulse, 1 volt in amplitude and 300 μ s in duration is generated, followed by an identical pulse 10 ms later. The two pulses are then repeated at 1.5 sec intervals with the time between them reduced 1.5 ms each time they repeat. A reset pulse from the 26G1 prevents the slew ramp from triggering the 26G3 at the peak of its excursion, producing an unwanted pulse.

OUTPUT CONDITIONING

One other important plug-in currently available in the 2600 Series is the 26A1 Operational Amplifier. It is a high-power operational amplifier ideal for final processing of signals generated in 2600-Series system. Output capabilities are ± 50 V and up to ± 50 mA. Open loop gain is 10,000 into a 1 k Ω load with a unity gain bandwidth of 5 MHz.

Access to the operational amplifier inputs and outputs is via a Terminal Access Adapter which plugs into the plug-in unit. The adapter also provides access to the front panel connectors and the regulated +15 and -15 volt supplies. Clips and jacks are mounted on the adapter circuit board so you can easily change the operational amplifier function. A Terminal Access Adapter kit which includes a circuit board with a 0.1 x 0.1 inch grid of plated-through holes is available for constructing circuits to meet your specific needs.

7000-SERIES COMPATIBILITY

The 2600 Series also brings new capabilities to you who own 7000-Series oscilloscopes. Through the use of an adapter, you can operate any of the 2600-Series plug-ins in your 7000-Series mainframe; truly plug-in versatility at its best.

TEKTRONIX FORM NUMBER
062-1265-00
(Pad of 50 sheets)

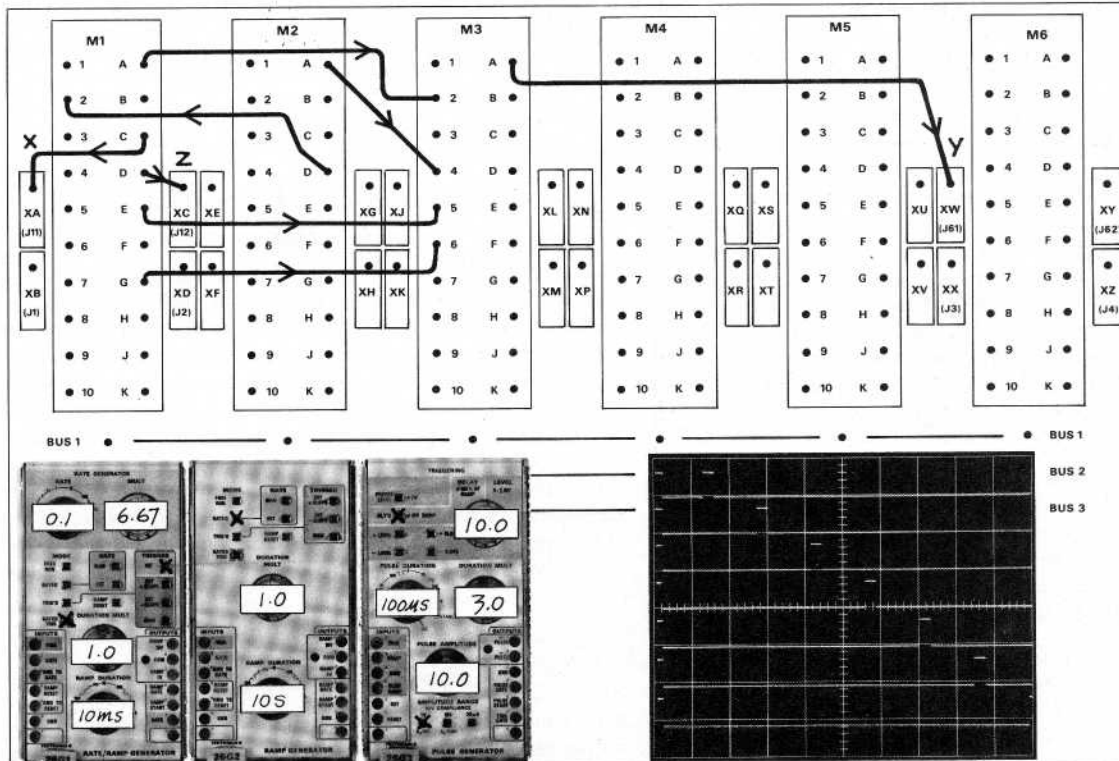

SYSTEM FUNCTION: Slew Pulses for Nerve Stimulation
USER: D. Clark
DATE: 2-1-71

INTERCONNECTION BOARD 670-0397-00

NOTES: A 10-second train of paired pulses, each pulse 300 μ s in duration, 1.0 volt in amplitude. Pulse pairs repeated at 1.5 second intervals with the time between pulses reduced 1.5 ms each repetition. Pin 15 of U70 in the 26G1 is connected to output G on the 26G1 for a reset pulse. A 601 Storage Display Unit serves as monitor.



Interconnection board worksheet shows connections between units, front panel control settings and waveforms generated by set-up. Notes include signal parameters and special instructions. Worksheet provides permanent record of set-up.

TEKNIQUE: *measuring the linearity of fast ramps*

By John McCormick, Project Engineer

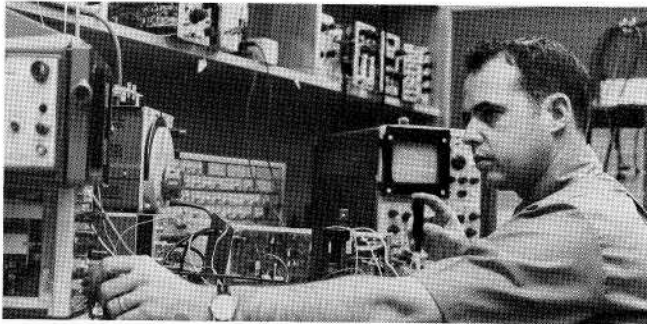

John received his BSEE, with distinction, from U of Kansas in 1962 and his MSE with a Materials Sciences Option from Princeton in 1965. With Tek since 1965, he has contributed much to fast-ramp technology while working on sampling sweeps.

The time measurements you make with your oscilloscope can only be as accurate as the time base displayed on the CRT screen. Improvements in components, ramp generator circuitry and CRT construction have given us time bases specified accurate within 2 or 3% and typically accurate within 1%. With the great strides being made in vertical amplifier bandwidth has come the challenge of providing the fast sweeps needed to properly display these higher-speed phenomena. Generating and measuring fast, linear ramps poses unique problems. This article discusses a solution for one of those problems, that of measuring the linearity of fast ramps.

There are two important quantities used to specify and describe a ramp. These are the mean slope of the ramp, and linearity or slope deviation from the mean. An ideal ramp has a constant slope and is perfectly linear. It is usually easy to measure the mean slope of the ramp but linearity measurements are difficult to make and are usually made in an indirect manner. This is especially true in the case of very fast ramps (tens of nanoseconds in length).

The terminology used to describe linearity varies according to the method used to measure it. A sampling oscilloscope can form the basis for a convenient and precise method of ramp slope and linearity measurements. However, before describing the method it will be necessary to define a few terms.

DEFINITIONS

Mathematically speaking, the slope of a waveform at any point in time is the derivative of the waveform with respect to time. If $V(t)$ is a voltage waveform, then the slope at any time is given by

$$\text{slope} = m(t) = \frac{dV(t)}{dt}$$

In the case of an ideal ramp, the slope would be constant. To describe a ramp we may consider an ideal ramp with the desired constant slope which we will call the mean slope, plus some deviations of the slope from this constant value.

$$m(t) = m_0 + l(t)$$

Where $m(t)$ is the actual slope at any given time, m_0 is the mean slope and $l(t)$ is the nonlinearity of the ramp.

Percentage of nonlinearity is expressed by the equation

$$\% \text{ Nonlinearity} = \left(\frac{m(t) - m_0}{m_0} \right) \times 100\% = \frac{l(t)}{m_0} \times 100\%$$

The nonlinearity is a function of time and can be determined if we know $m(t)$ and m_0 . It is relatively easy to measure m_0 by feeding the ramp into the vertical system of a scope and measuring its amplitude and duration; $m(t)$ is the time derivative of the ramp waveform. It is possible to measure an approximation to $m(t)$ by several methods, only one of which we will discuss in detail here.

The derivative of a voltage that is a function of time $V(t)$ is given by the basic definition:

$$\frac{dV(t)}{dt} = m(t) = \lim_{\Delta t \rightarrow 0} \frac{V(t+\Delta t) - V(t)}{\Delta t}$$

What we can measure is

$$m^*(t) = \frac{V(t+\Delta t) - V(t)}{\Delta t \text{ finite}}$$

It is obvious that $m^*(t)$ is just the average slope of the function $V(t)$ measured over a time Δt at each point in time as in Fig. 1. A convenient name for Δt is the time resolution or simply, the "resolution" of the measurement. The resolution is indicative of the detail that can be resolved. If the slope $m(t)$ has components which last for a time on the order of Δt as in Fig. 1, they will be smoothed out in the measurement. If the ramp has a fast start like the ideal ramp in Fig. 2(a), then the $m^*(t)$ Fig. 2(c) will differ from the actual derivative in Fig. 2(b) because of the finite resolution time. The smaller the resolution time, the closer $m^*(t)$ will be to $m(t)$. Now let's consider methods of measuring $m^*(t)$.

MEASUREMENT OF $m^*(t)$

One simple way to obtain $m^*(t)$ for a waveform would be to process the waveform with an analog differentiator as in Fig. 3. This works pretty well with slow ramps but is very difficult to implement for fast ramps. A better method for fast ramps makes use of sampling techniques to time-convert the ramp to a slower-speed replica. Measuring the slope is then an easy matter. The technique shown in Fig. 4 can be used to measure $V(t+\Delta t)$ and $V(t)$. The ramp waveform is fed into two identical sampling heads, A & B, each of which produces a DC voltage in its respective memory, proportional to the value of the ramp voltage at a time t_s when the strobe opens

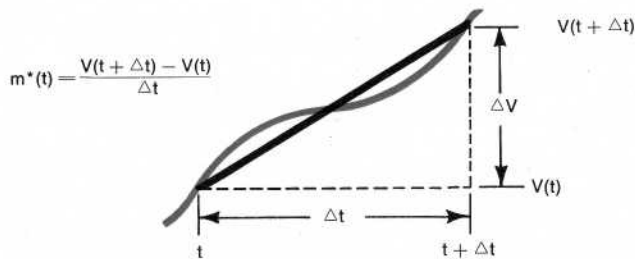

Fig. 1. Resolution limits measurement detail. Components lasting for a time on the order of Δt will be smoothed out.

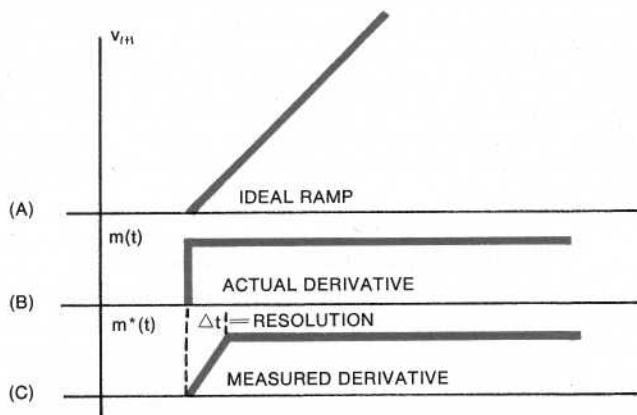

Fig. 2. Measured slope differs from the actual derivative because of the finite resolution time.

the sampling gate. If the strobe time for channel A (t_{SA}) is made different from that for channel B (t_{SB}) by some time (Δt) due to unequal delays T_A and T_B , then the voltage measured by the respective sampling heads will be

$$V_{SA} = V(t_{SA}) \quad V_{SB} = V(t_{SA} + \Delta t)$$

We can then subtract them at each time t .

$$V(t)_{B-A} = V_{SB} - V_{SA} = (V(t + \Delta t) - V(t))$$

If we divide the difference in strobe time Δt we have

$$\frac{V(t)_{B-A}}{\Delta t} = \frac{(V(t + \Delta t) - V(t))}{\Delta t} = m^*(t)$$

A convenient realization of the above technique can be obtained with a sampling system set up as in Fig. 5. The system consists of a 7000-Series four-compartment mainframe, a 7T11, two 7S11's, two S-1 sampling heads and a 7A22. If the signal cannot be loaded by 50Ω then a probe such as the P6034, P6035 or P6051 can be used to couple the signal to the power divider tee. An alternate approach would be to use S-3A or S-5 sampling heads in place of the S-1.

The gains of both sampling channels should be adjusted so that they are equal (note variable front panel control on the 7S11 does not effect the gain of the vert sig out). This can be done by inserting a variable attenuator in the leads from the vert sig out to the 7A22. Comparing the amplitudes of the two vertical signals out is easily done with the 7A22. Just feed both signals differentially into the 7A22 and adjust the gains until the base line is at the same level before and after the ramp.

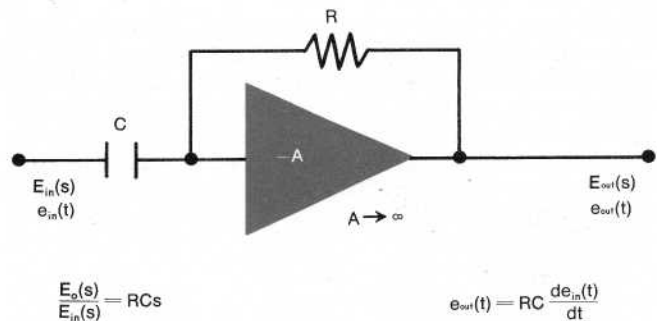

Fig. 3. Analog differentiator is a convenient means of measuring slope and linearity of slower ramps.

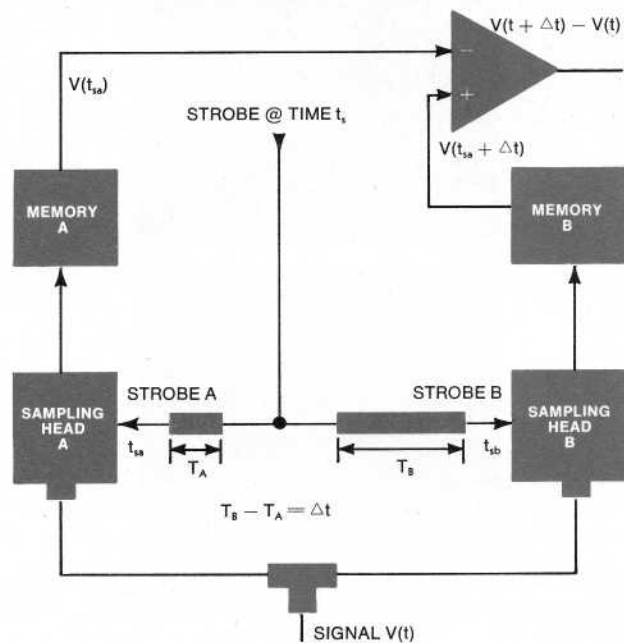

Fig. 4. Block diagram of a sampling system to measure $V(t + \Delta t) - V(t)$. Resolution is set by difference in time of T_A and T_B .

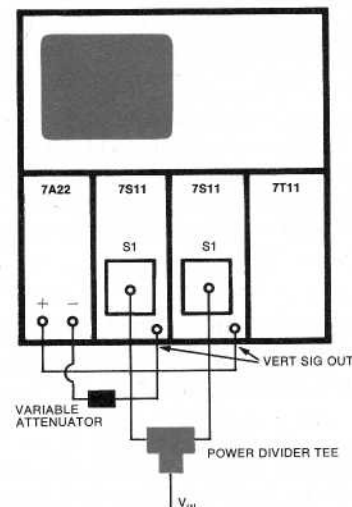
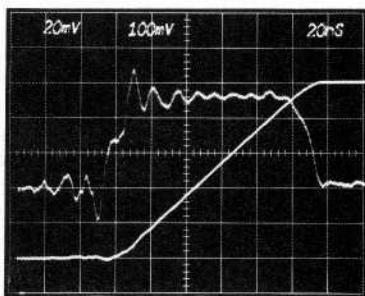
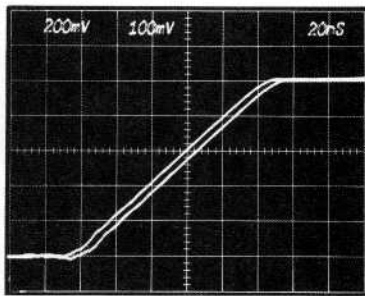

Fig. 5. 7000-Series system to measure ramp (Vt) and slope (m^*t) and display them simultaneously. Attenuator is placed in series with 7A22 input having largest signal so inputs to 7A22 may be set to same amplitude.

The resolution should be set by turning the right hand 7S11 Delay Control full CCW, grounding the negative input of the 7A22 and setting the left hand 7S11 Delay Control for the desired Δt by observing the separation of the two traces on the screen. Be sure to adjust the gain of the 7A22 using the variable if necessary so that the two traces have the same amplitude on the screen. The top photo below is a typical display for setting resolution.



Top photo is typical display for setting resolution. Bottom photo shows ramp and its slope. Aberrations are caused by nonlinearities in the ramp. Resolution is 6 ns.

After setting the desired resolution or Δt , the negative input of the 7A22 is moved to the DC position. Now displayed on the CRT is the voltage differential between the outputs of the samplers which is proportional to Δt and the slope of the ramp. Measuring the amplitude of this voltage differential and knowing Δt we arrive at $m^*(t)$ or the slope of the ramp.

The bottom photo above shows the slope waveform and the ramp whose slope it represents. Aberrations on the slope waveform are due to nonlinearities in the ramp. The amplitude of these aberrations relative to the amplitude of the slope waveform is the measure of the nonlinearities that exist in the ramp.

ACCURACY OF THE MEASUREMENT

Although the absolute slope in volts per nanosecond can be measured with this system, the accuracy is not as good as it is when measuring linearity unless the system is calibrated with a known slope. Contributing to the accuracy of the slope measurement are the accuracy of the sampling channel gains, the accuracy of the 7A22 gain, and the accuracy with which the time Δt is known.

One method of eliminating the problem of absolute sweep calibration for accurate Δt is to adjust for both channels to

sample at the same time and add a known length of delay line in the signal path of one of the sampling channels.

Two other factors effect the accuracy of the linearity measurements. These are nonlinearity in the vertical response and nonlinearity in the sampling sweep. Of the two, the sweep nonlinearity is the dominate effect. The linearity of the sweep is specified to be within 3% over most of the Time Position Range and can be checked by the usual method with accurate time marks. For sweep speeds with low magnification the linearity is typically better than 1%.

PRECISION OF THE MEASUREMENT

Precision refers to the ability to measure small differences in signal amplitude and is limited primarily by noise. With the system described we can easily measure 1% differences in slope. It must be borne in mind that the response of the 7S11's must be identical. A convenient way to assure this is to set the dot response of both 7S11's to unity. It is also important that the scan rate be slow enough for the bandpass used on the 7A22.

RANGE OF SLOPE MEASUREMENTS

The upper limit on slope, $m^*(t)$, in volts/nanosecond is determined by the risetime of the sampling system and our ability to set the resolution to be a small portion of the ramp. Ten to twenty percent of ramp duration yields good results. The system described provides resolution from 10 ns to less than 100 ps. We should keep in mind that as the resolution time decreases, so does the signal out and noise will be a problem. The 7A22 variable bandpass may be used to reduce noise but the display rate must decrease proportionally. This is easily done by varying the scan control on the 7T11.

The lower limit on $m^*(t)$ in volts/nanosecond is set by noise as the resolution time cannot be adjusted greater than 10 ns without instrument modification. A useful lower limit set by noise places the longest ramp length that can be measured with this system at about 500 ns. However, an external delay line can easily be inserted in the signal path of one sampling channel to extend the lower limit.

CONCLUSION

We have discussed how differentiation of a fast ramp leads to a convenient method of measuring ramp linearity and have shown how to construct such a measurement system. A ramp and its slope, $m^*(t)$, are shown in the bottom photo at left. The resolution is about 5% of the ramp length. The risetime of the slope can be measured as well as amplitude, overshoot, ringing and droop, just as if measuring a step response, and these quantities all relate to how linear the ramp is at any point. The advantage of having the ramp and the slope displayed simultaneously is that the effect of circuit adjustments affecting the slope are seen immediately.

The ability to differentiate fast waveforms can be useful in other applications as well, such as measuring impulse response by differentiating the step response. Differentiation of theoretical expressions has always been a useful technique in certain analysis (such as linearity of ramps), but with the ability to measure the derivative directly and display it, although limited by resolution time, the technique becomes even more useful.

SERVICE SCOPE

SERVICING THE 7704 HIGH-EFFICIENCY POWER SUPPLY

By Charles Phillips

Product Service Technician, Factory Service Center

This is the first in a series of articles on servicing the 7000-Series oscilloscopes. The 7704 serves as the basis for these articles since it contains most of the new circuitry, components and construction techniques we will be discussing. It is not our intent to discuss the general techniques used in troubleshooting oscilloscope circuitry as these were covered extensively in the February 1969 to February 1970 issues of *TEKSCOPE*. Copies of these articles are available through your field engineer.

Proper operation of the regulated low-voltage supplies is essential for the rest of the scope circuitry to function properly, so let's look at this section first.

The high-efficiency power supply used in the 7704 is a new concept in power supply design that results in appreciable savings in volume, weight and power consumption. It is called "high efficiency" because its efficiency is about 70% as compared to 45% for conventional supplies. The line-to-DC converter/regulator contains most of the unconventional circuitry so our discussion will deal primarily with this portion.

First, let's briefly review the theory of operation. The high-efficiency power supply is essentially a DC-to-DC converter. The line voltage is rectified, filtered and used to power an inverter which runs at approximately 25 kHz. The frequency at which the inverter runs is determined basically by the resonant frequency of a series-LC network placed in series with the primary of the power transformer. The inverter drives the primary of the power transformer supplying the desired secondary voltages. These are then rectified, filtered and regulated for circuit use.

Pre-regulation of the voltage applied to the power transformer is accomplished by controlling the frequency at which

the inverter runs. A sample of the secondary voltage is rectified and used to control the frequency of a monostable multivibrator. This multivibrator, in turn, controls the time that either half of the inverter can be triggered, thus controlling the inverter frequency. Circuit parameters are such that the multivibrator, and hence the inverter, always runs below the resonant frequency of the LC network. Remembering that the resonant LC network is in series with the primary of the power transformer, we can see that as the inverter frequency changes, the impedance of the LC network changes. The resultant change in voltage dropped across the LC network keeps the voltage applied to the primary constant. Pre-regulation to about 1% is achieved by this means.

Now, let's turn our attention to troubleshooting the supply. Assume you have made the usual preliminary checks; you have power to the instrument, the line selector on the rear of the instrument is in the correct position for the applied line voltage and the line voltage is within specified limits. The plug-ins have been removed to eliminate the possibility of their causing the power supply to malfunction.

With the instrument power off, check the two fuses located in the line selector cover on the rear of the instrument. If the line fuse, F800, is open the problem is probably in the line input circuitry. If the inverter fuse, F810, is open the inverter circuitry is probably faulty. In either case it will be necessary to remove the supply from the mainframe to make further checks. This is easily done by removing the four screws on the rear panel that secure the power unit, then sliding the unit out the rear of the instrument.

Before removing the power-unit cover, check to see that the neon bulb on the left side of the power unit has stopped flashing. The primary storage capacitors C813 and C814

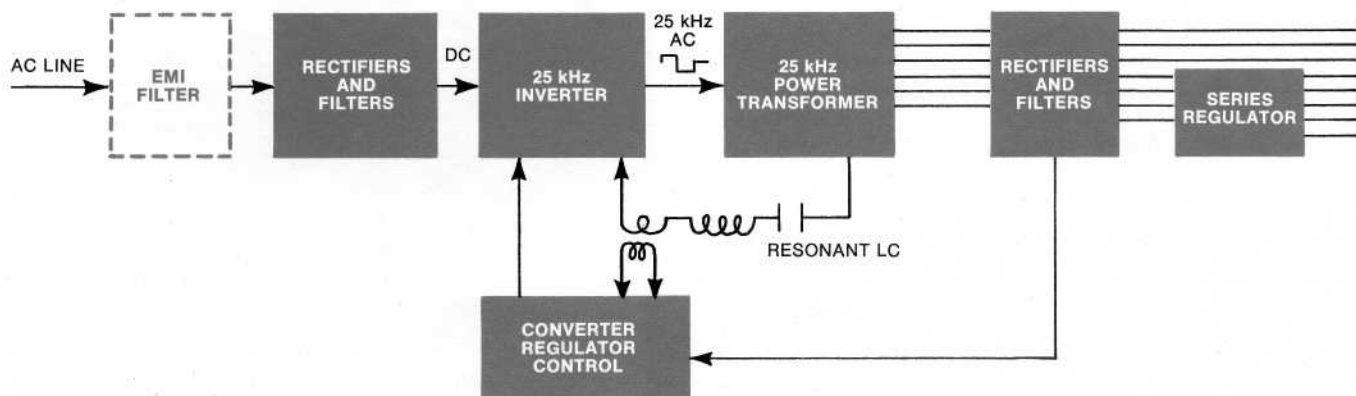

Simplified block diagram of high-efficiency low-voltage power supply.

remain charged with high voltage DC for several minutes after the power line is disconnected. When this voltage exceeds about 80 volts the neon bulb flashes. While servicing the power unit, the discharge time of the storage capacitors can be speeded up by temporarily disabling the inverter stop circuit. Pulling Q864 before turning off the scope power will allow the inverter to keep running for a short time, thus draining most of the charge from the capacitors. A voltmeter reading between test points 810 and 811 on the line input board will indicate the charge remaining on the storage capacitors. Allow at least one minute for the current-limiting thermistors to cool before turning on the power again if you use this fast-discharge technique. Do not attempt to discharge the capacitors by shorting directly across them as this will damage them.

With the power-unit cover removed, orient the supply with the rectifier board on top, the line input board on the left and the inverter board on the right. This will make it convenient to get to all the test points as we go along.

LINE INPUT BOARD

First let's check the line input board. It's fairly easy to tell if this circuit is working. The neon bulb previously mentioned will start flashing when power is applied. On some units it assumes a steady glow, on others it continues to flash. The voltage reading on test points 810 and 811 should be approximately 300 volts DC depending upon the line voltage. Be careful not to ground any point in this circuit except test-point ground or chassis.

Typical troubles in this circuit causing the line fuse to open are shorted diodes on the bridge, CR810, or a shorted capacitor C810, C811, C813 or C814.

INVERTER BOARD

Next in line is the inverter circuit. The problems most common to this circuit are open fuse F810, shorted transistors Q825 or Q835, or shorted diodes CR825, CR835, CR828 or CR838. An open inverter fuse usually indicates trouble in the inverter.

Before working in this circuit, unplug the power cord and give the storage capacitors time to discharge. Remove the line selector cover containing the line and inverter fuses. We're now ready to make some resistance checks on the inverter board.

With your ohmmeter set to the $\times 1$ k Ω scale, take a reading between test points 826 and 836. The reading should be several megohms in one direction and ≈ 1.5 k Ω with the test leads reversed. Check between test points 836 and 820. You should get a high and low reading as before. This checks the transistors and important diodes in the inverter stage. If you get a low reading in both directions on either of these tests, remove the transistor from the side having the low reading in both directions. A set of readings between the appropriate test points will show whether it is the diode or the transistor that is defective. Diodes CR826 and CR836 are not checked by the above procedure but will not prevent the inverter from running even if shorted. Once you achieve a high resistance on both sides of the inverter, it will probably operate when you apply the proper power to it. However, before applying power, a quick check should be made on rectifier board test point 860 to ground. The resistance should be ≈ 2 k Ω or 40 k Ω depending on the polarity of the meter leads.

You can now prepare to apply power to the instrument. Install the line selector cover. Remove Q860 to disable the pre-regulator circuit. Connect your test scope between test point 836 and ground on the inverter board. Vertical sensitivity should be 50 V/div DC at the probe tip, the trace centered and the sweep speed set to 10 μ s/div. Connect a voltmeter between the +75 V test point and ground on the rectifier board. Plug the scope into an autotransformer and with the line voltage set at zero volts, turn the instrument on. Slowly advance the line voltage while watching the test scope. If the trace moves up or down, the inverter still has problems. If the trace holds steady, the inverter should start as the line voltage approaches 80 volts. A square wave of approximately 25 kHz and 200 volts will appear on the test scope. Do not advance the line voltage any further. The +75 volt supply should not be allowed to exceed 75 volts to prevent blowing the inverter fuse.

RECTIFIER BOARD

You are now ready to check the pre-regulator circuitry. Turn off the scope and return the line voltage to zero volts. Replace Q860 in its socket. Slowly advance the line voltage while monitoring the +75 volt supply. If the +75 volts holds steady, you can advance the line voltage to a normal setting. If the voltage is not stable or if the signal being monitored on test point 836 on the inverter board is erratic in frequency, the pre-regulator is not working properly. The quickest method of troubleshooting this circuit is to check the associated transistors with a curve tracer or ohmmeter. The waveforms shown on the facing page are typical for a properly operating supply.

MECHANICAL CONSIDERATIONS

Most of the components in the power supply are readily accessible from the top of the printed circuit boards. However, when it is necessary to remove a soldered-in component, we suggest you remove the circuit board from the assembly and unsolder the component from the back side of the board. The line input board and the rectifier board are readily

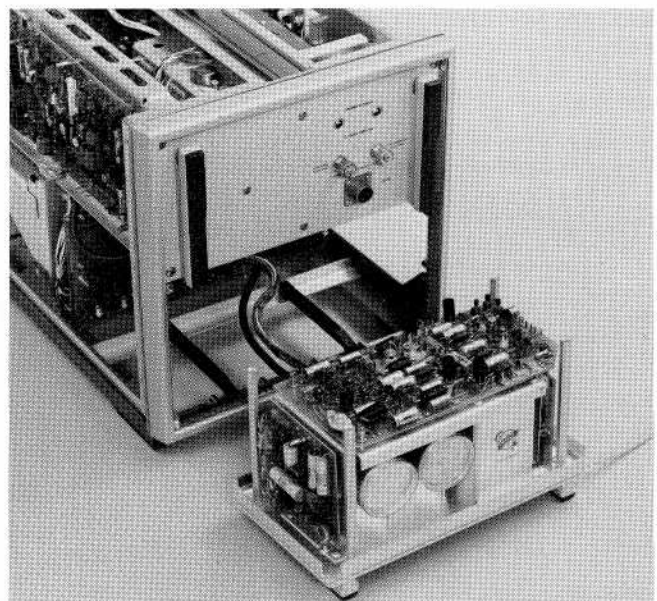

Low-voltage supply removed for easy servicing. Line input board is on the left side, rectifier board on top, and just the edge of the inverter board is visible at the right.

removed by loosening two or three screws. The inverter board is somewhat more difficult to remove; the manual gives the proper procedure.

Care should be exercised when replacing Q825 or Q835 located on the ceramic heat sink on the inverter board. The mounting studs are soldered into the printed circuit board and may be broken loose by applying excessive torque.

When placing the power unit back into the mainframe take care to properly dress the power unit cables between the power unit and the logic board. Lowering the swing-down gate on the right side of the instrument will let you guide the cables into place.

In the next issue of **TEKSCOPE** we will discuss the 7704 high voltage power supply.

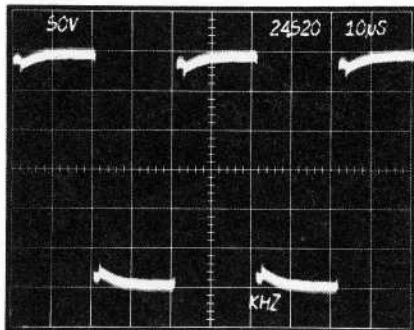

Typical waveform at TP836 for properly operating supply. Mid-screen is 0 Volts.

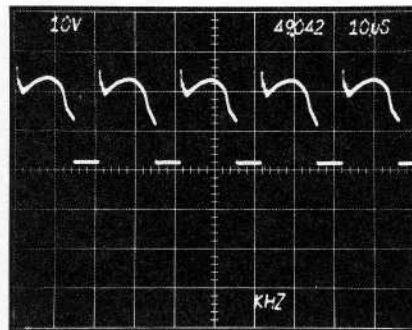

Waveform at TP860. Note frequency is twice that at TP836.

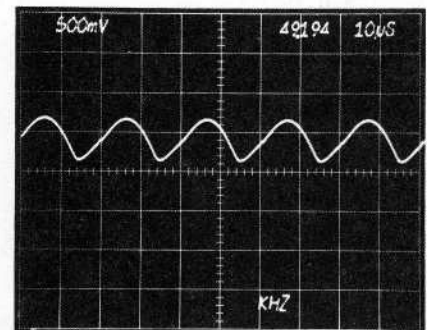

Waveform at TP859. Frequency increased slightly due to line voltage change.

INSTRUMENTS FOR SALE

561A, \$500. 3T77, \$500. 3S76, \$850. Harold Dove, 837 Uvalda St., Aurora, Colo. 80010. (303) 343-2906.

3-514D, 514AD, 524AD, 502, 541, 543A, 180A. 2 ea. 160A, 161, 163, 162. Jim Kennedy, Technitrol, Inc., 3825 Whitaker Ave., Phila., Pa. 19124. (215) 426-9105.

575, \$900. Hans Frank, Dynaco, Phila., Pa. (215) CE 2-8000.

502A, 202-1. Ron Calvanio or Dr. Denton, Mass. Gen'l. Hospital, Dept. of Anesthesia, Fruit St., White Bldg., Boston, Mass. 02114. (617) 726-3851, 726-2034.

2 ea. 513D, 517. Dr. Frederic Davidson, E.E. Dept., Johns Hopkins Univ., Baltimore, Md. 21218. (301) 366-3300, Ext. 249.

515A. G. Katzen, 243 W. Main St., Cary, Ill. 60013. (312) 639-4768.

601, \$925. Dr. William Spickler, Cox Heart Institute, 3525 Southern Blvd., Kettering, Ohio 45429.

514D, \$250 or trade for 3 in. model. Arthur Pfalzer, Hoover Electric, Hangar 2, Port Columbus Airport, Columbus, Ohio 43219. (614) 235-9634.

561A, 3A6, 3B4. Package price, \$1250. Pierre Cathou, MIT Branch, P.O. Box 104, Cambridge, Mass. 02139. (617) 868-5782.

53G, \$100. 53/54B, \$85. Dan McKenna. (517) 725-7211.

2-453. Dave Ballstadt, Optical Digital Systems, 1175 E. Highway 36, St. Paul, Minn. 55109. (612) 484-8589.

513D. Lou Chall, 2834 Serange Place, Costa Mesa, Calif. 92626. (714) 545-6536.

549, 1A1, 202-2, \$2800 complete. J. C. Davis, Republic Nat'l Bank, Sunset Plaza, Pueblo, Colo. 81004.

611. Dr. Les Wanninger, General Mills, Inc., 9000 Plymouth Ave., N., Golden Valley, Minn. 55427. (612) 540-3444.

561A, 3A6, 3B3. Excellent condition. \$1000. Might accept 321 or 321A as part payment. (213) 792-4962.

323, \$850. C30AP, New, \$450. Harold Moss. (213) 398-1205.

536, 53/54K, 53/54T, \$800. S54, \$300. Geo. Schneider, Profexray Div., Litton Medical Products, 1601 Beverly Blvd., Los Angeles, Calif. 90026. (213) 626-6861.

511AD, \$300. Carl Powell, 3906 Jackson Hwy. Sheffield, Ala. 35660. (205) 383-3330.

13-RM561A/2A60/2B67 never used. Attractive discount. J. Wieland, 16950 Encino Hills Dr., Encino, Calif. 91316.

316, \$600. I. R. Compton, Comptronics, 3220 - 16th West, Seattle, Wash. 98119. (206) 284-4842.

2B67, \$175. 63 Plug-In, \$100. Roger Kloepfer. (517) 487-6111, Ext. 392.

514A. Geo. Butcher, Electronics Marine, P.O. Box 1194, Newport Beach, Calif. 92663. (714) 673-1470.

1L20. George Bates, Dynair Elect., 6360 Federal Blvd., San Diego, Calif. 92114. (714) 582-9211.

611, \$2000. Dr. A. Sanderson, Harvard Univ., Electronics Design Center, 40 Oxford St., Cambridge, Mass. 02138. (617) 495-4472.

P6046 Probe, Amplifier, P.S., \$600. Bob Waters, Jr., ARCT, Inc., P.O. Box 11381, Greensboro, N.C. (919) 292-7450.

503 w/Grid. Wm. Gelb, Gelb Printing & Lithographing Co., 6609 Walton St., Detroit, Mich. 48210. (313) 361-4848.

555 complete. Scope Cart. Fred Samuel, Ch. Engr., WXTV, Ch. 41, 641 Main St., Paterson, N.J. 07503. (201) 345-0041.

547, 422, 453, 502, Plug-Ins, Cal. Fixtures. Manzano Laboratories, Inc., 146 Quincy Ave., N.E., Albuquerque, N.M. 87108. (505) 265-7511.

514AD, \$260. J. Barsoomian, 31 Porter St., Watertown, Mass. 02172. (617) 924-6475.

2-531A/CA, \$895. 2-531/CA, \$695. 53/54C, \$150. 2A63, \$125. J. Boyd, Tally Corp., 8301 180th South, Kent, Wash. 98031. (206) 251-5500, Ext. 6787.

545B, 1A1, 1A7. Scientific Industries, 150 Hericks Rd., Mineola, N.Y. (516) 746-5200.

547, 1A4, 1A2, 202-2, as package or individually. Phil DiVita, Data Display Systems, Inc., 139 Terwood Rd., Willow Grove, Pa. 19090. (215) 659-6900.

105, \$100. Charles Yelverton, Jones County Jr. College, Ellisville, Miss. 39437. (601) 764-3667.

516, \$1020. 564B/121N, \$876. 3A6, \$440, 3B3, \$544. 545B, \$1360. 1A1, \$520, 1A6, \$236. 201-1, \$116. 201-2, \$124. 202-2, \$124. Larry Glassman, 5584 Benton Woods Dr., N.E., Atlanta, Ga. 30342. (404) 255-5432.

531A, CA, 202 Mod. A, \$500 package. Tom Eckols, Dow Jones Co., Dallas, Texas. (214) ME 1-7250.

INSTRUMENTS WANTED

453. W. Pfeiffer, 1332 E. Portland, Springfield, Mo. 65804. (417) 869-0249.

519. John Barth, Barth Corp., 7777 Wall St., Cleveland, Ohio 44125. (216) 524-5136.

503. A. Ruben, Medical Sales & Service, 270 E. Hamilton St., Allentown, Pa. 18103. (215) 437-2526.

R561A or B, with or without Plug-Ins. Dr. Paul Coleman, Univ. of Rochester Medical Cntr., Anatomy Dept., Rochester, N.Y. 14620. (716) 275-2581.



TEKSCOPE

Volume 3

Number 2

March 1971

Customer Information from Tektronix, Inc., P.O. Box 500, Beaverton, Oregon 97005
Editor: Gordon Allison Artist: Nancy Sageser For regular receipt of TEKSCOPE contact your local field engineer.

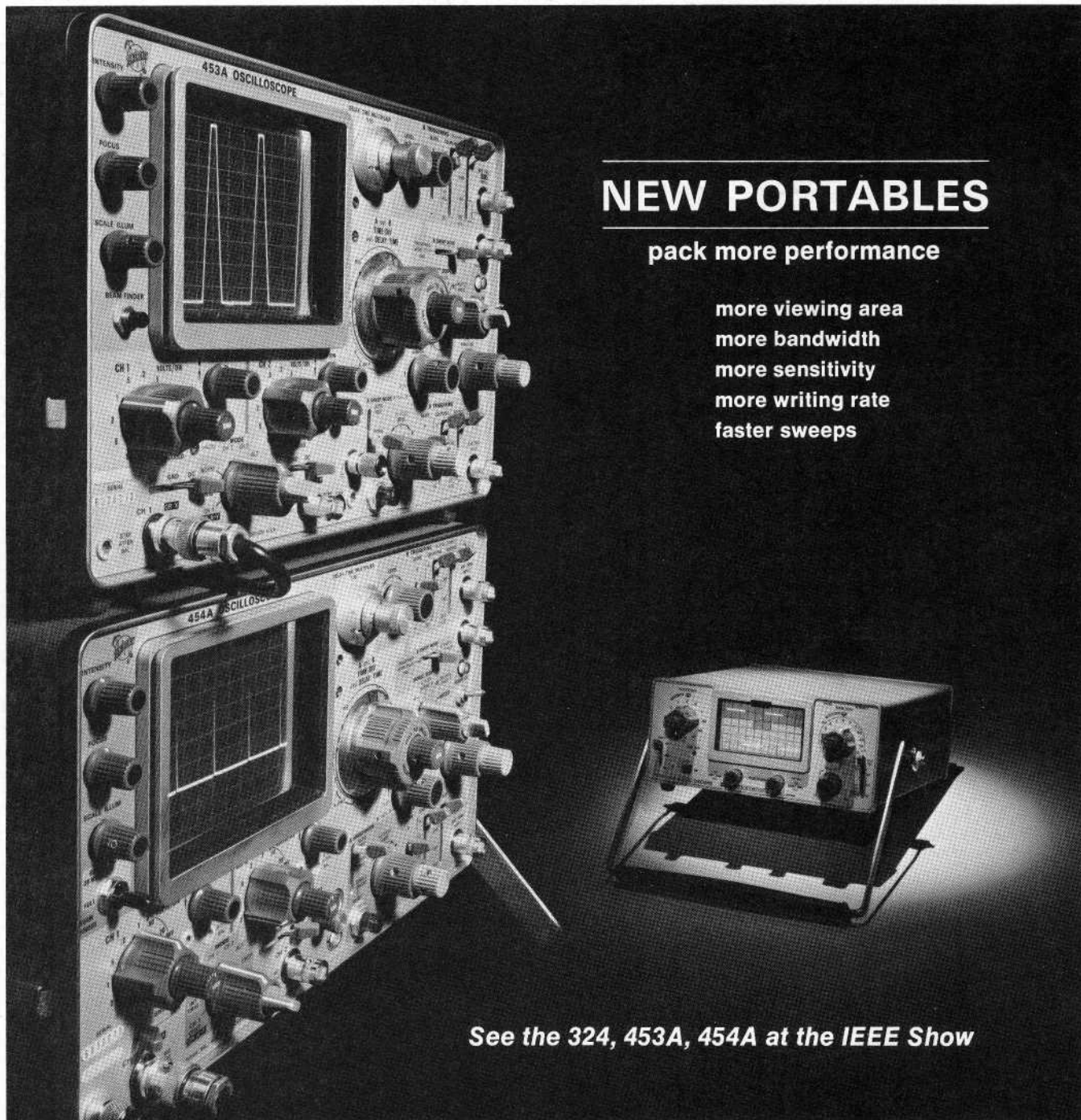

NEW PORTABLES

pack more performance

more viewing area
more bandwidth
more sensitivity
more writing rate
faster sweeps

See the 324, 453A, 454A at the IEEE Show

TEKTRONIX, INC.
P.O. BOX 500
BEAVERTON, OR. 97005

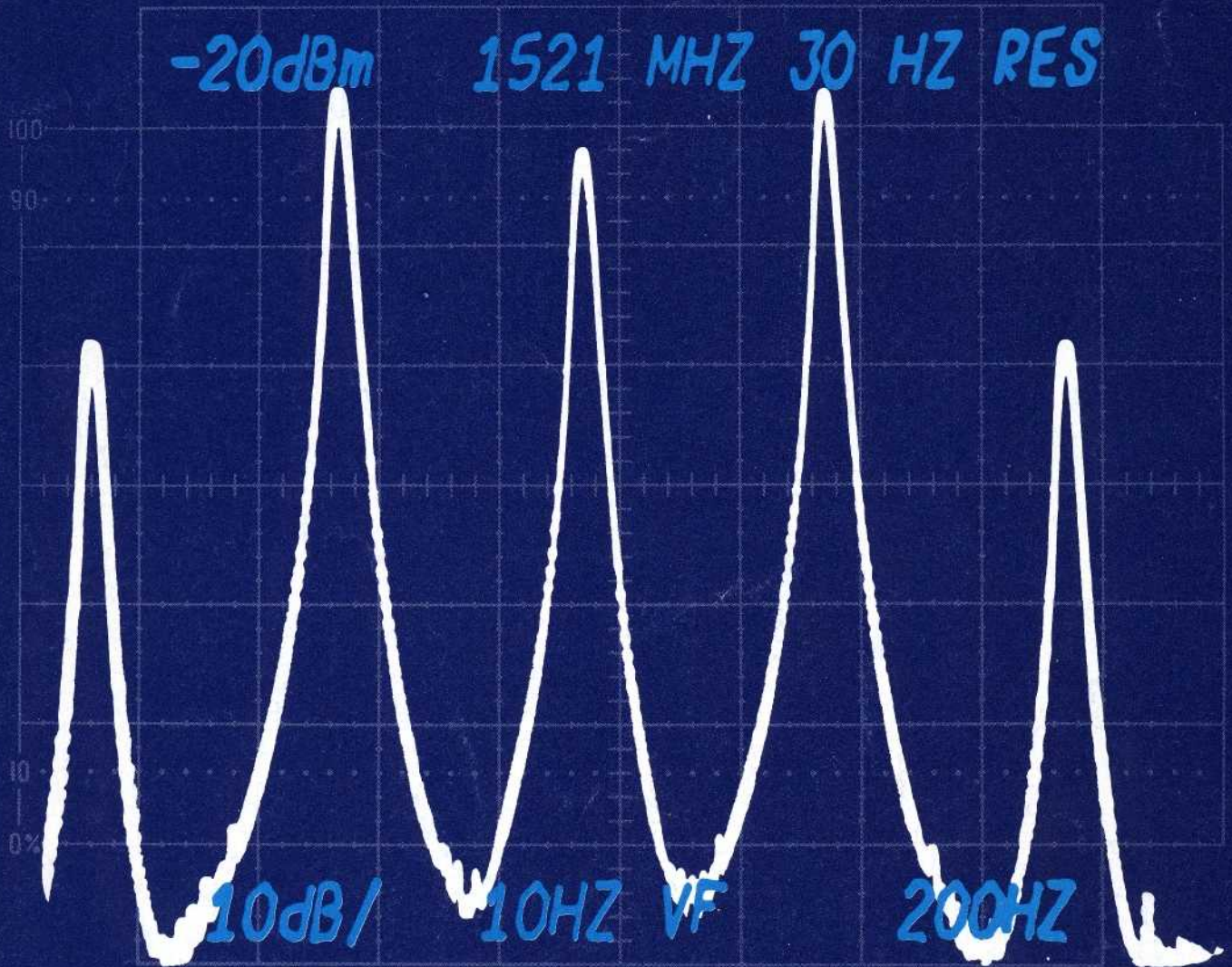

Customer Information from Tektronix, Inc.,
P.O. Box 500, Beaverton, Oregon 97005

Editor: Gordon Allison,
Graphic Designer: Tom Jones

Contents

3 **30 Hz resolution at gigahertz frequencies—a new direction in spectrum analysis**

Low incidental FM and excellent stability permit exacting measurements in the areas of spectral purity and close-in distortion.

8 **CRT READOUT—nicety or necessity?**

CRT READOUT offers many benefits to the scope user. Provision is made to insert your own data.

10 **Flexible disc measurements simplified by digital delay**

A digital delay plug-in for 7000-Series Oscilloscopes, used in the Delay-by-Events mode, takes the jitter out of rotating disc measurements.

13 **Servicing the 465 Portable Oscilloscope**

Some troubleshooting hints and typical problems you may encounter in servicing the 465 Oscilloscope.

Cover: A close-up view of the display of the 7L13 Spectrum Analyzer. The CRT Readout displays the Spectrum Analyzer control settings. Center frequency is 1521 MHz, frequency span is 200 Hz/div, resolution is 30 Hz and the video filter is set at 10 Hz. The reference level at the top of the screen is -20 dBm and the vertical deflection factor is 10 dB/div.

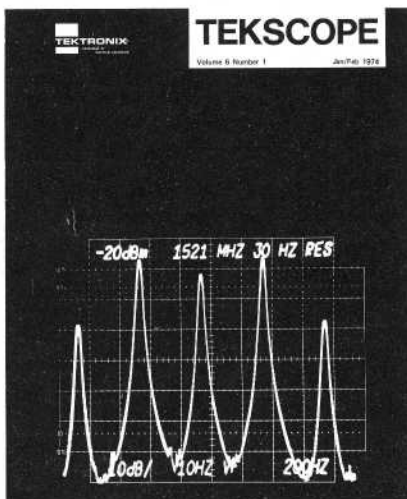



F. Telewski

30 Hz resolution at gigahertz frequencies— a new direction in spectrum analysis

For some years the needs of high-frequency spectrum analysis in the area of DC to 2GHz have been satisfied by a number of instruments whose incidental FM was in the order of 200 Hz. While these instruments have served well they do not permit exacting measurements in the areas of spectral purity and close-in distortion. As a result, the user is often compelled to adopt alternate test procedures which require the use of down-converters and low-frequency spectrum analyzers or wave

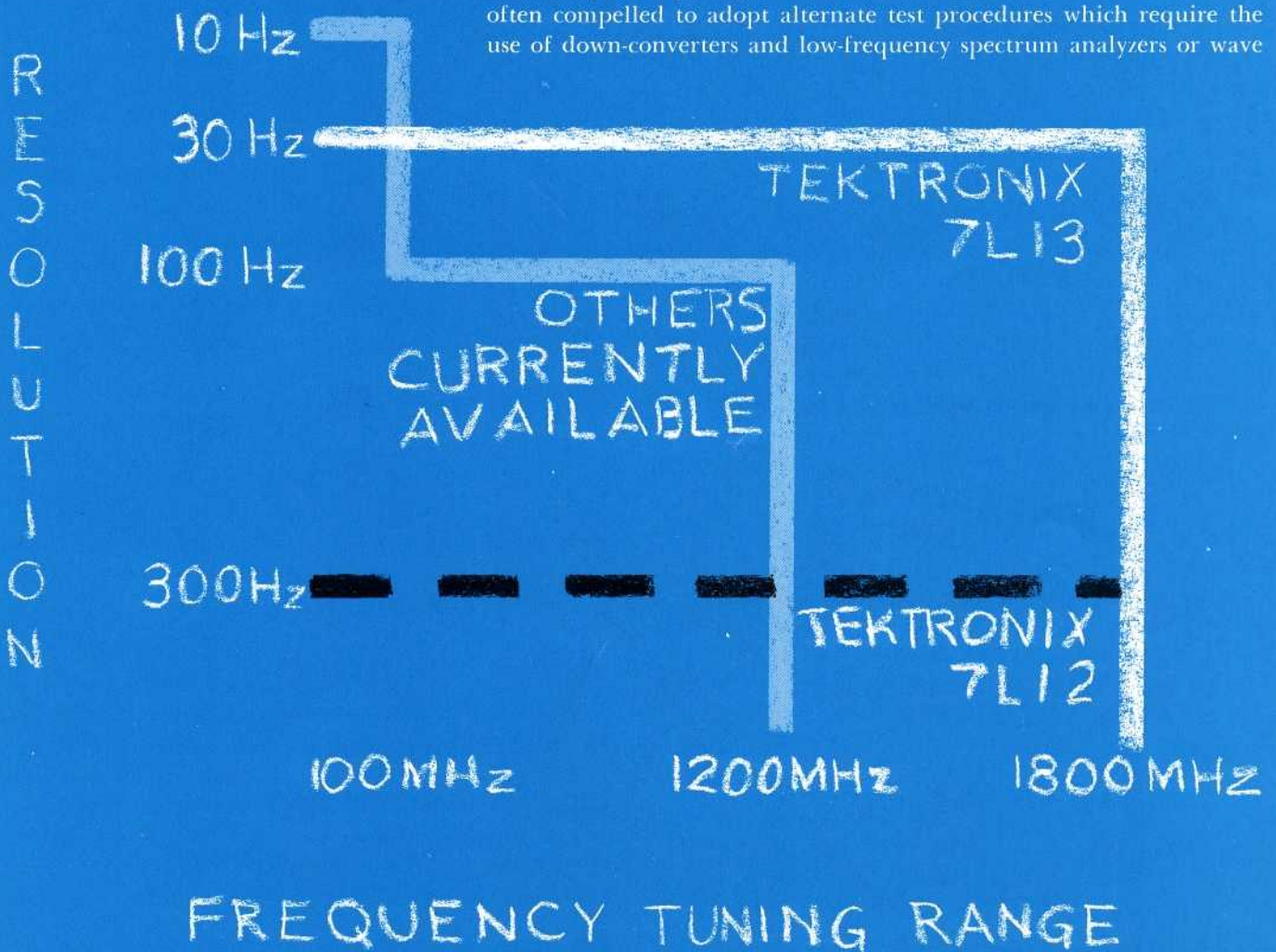

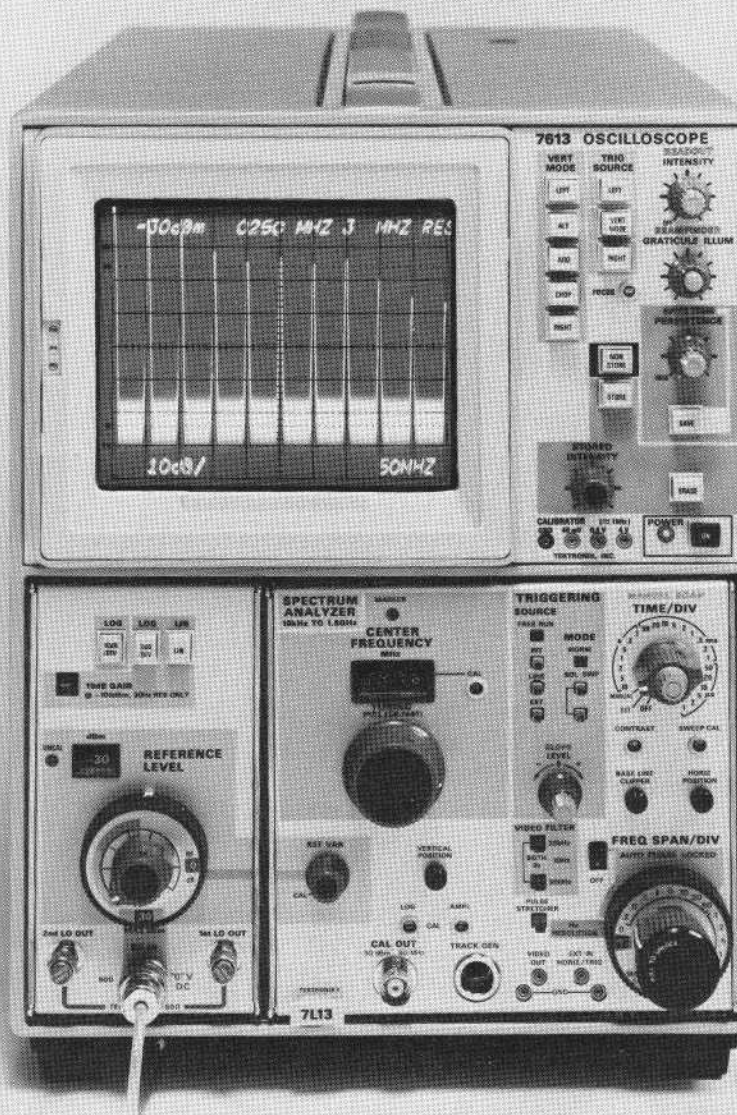

analyzers. The cumbersome nature of these measurement systems coupled with the tightening of signal specifications by governmental regulatory agencies has created a need for a high performance, high-frequency spectrum analyzer.

Performance Goals

At inception, the 7L13 program aimed at reducing internal FM and drift by an order of magnitude with commensurate improvement in resolution capability. Keeping in mind that most spectrum analyzers are already somewhat difficult to operate, these improvements could not be accomplished at the expense of operational ease. Indeed, additional improvements in operational simplicity should be sought.

First Local Oscillator

It is the local oscillator system that determines the performance achievable in most spectrum analyzers. An examination of the oscillator system reveals that there are basically two oscillators under consideration. These are the 1st L.O. (2.1 - 3.9 GHz) and the 2nd L.O.

(2.2 GHz) as shown in Fig. 1. The 3rd L.O. being crystal-derived at 95 MHz contributes negligible FM ($\ll 1$ Hz p-p) to the system.

It is common practice, as the frequency span is reduced, to phase lock the 1st L.O. to a fixed crystal reference oscillator, thus stabilizing it while shifting the sweep function to the 2nd L.O.¹ The rate of the crystal reference oscillator determines the range over which the 2nd L.O. must be swept in order to complete the frequency coverage between the discrete lock points. Hence, a low-frequency reference is desirable from the viewpoint of design ease in the 2nd L.O. system.

The choice of a crystal reference rate is compromised by the high phase noise associated with low-frequency references. The increase in noise arises from the requirement for a higher multiplication rate of the fundamental oscillator, whose behavior is characterized by the following equation:

$$DEG_{dB} = 20 \log M,$$

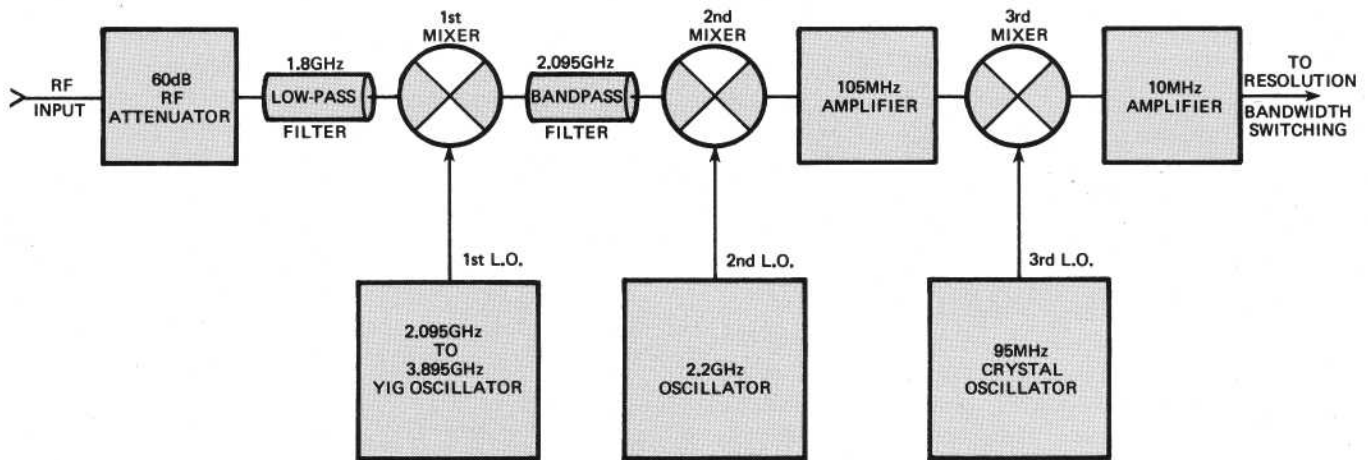

Fig. 1. Frequency conversion system of the 7L13.

Where: DEG is the degradation in spectral purity in dB and M is the multiplication factor. From the standpoint of phase noise it is desirable to choose a high rate for the crystal reference oscillator; however, conflicting requirements result. A 1-MHz reference rate is chosen as medium ground for the 1st L.O. reference. This permits a reasonable 2nd L.O. tuning range of 3 MHz as well as satisfying the phase noise constraint.

There is a unique bandwidth for any oscillator servo system which will yield optimum spectral purity. This bandwidth is determined by considering the relative spectra of the reference oscillator and the voltage-tuned oscillator (VTO) which is to be locked. In the 1st L.O. servo loop, the loop bandwidth is chosen such that the excellent line-width properties of the crystal reference are translated to the YIG VTO. The broad noise pedestal associated with the same reference is rejected in favor of the faster falling noise sidebands of the YIG VTO. The FM performance of this system, when operating in the lock mode, is in the 1 Hz p-p area.

2nd Local Oscillator

The 2nd L.O. usually consists of a varactor-tuned oscillator operating in the region of 1.5 to 2.5 GHz. Examination of the properties of this oscillator type indicates that under reasonable circumstances, 200 Hz is the minimum residual FM that can be expected as guaranteed performance without resorting to external stabilization techniques.

Improving the performance of the 2nd L.O. becomes a problem of designing an oscillator at a frequency where the desired stability and tuning range can be achieved. In this case a voltage-tuned oscillator operating from 16 to 19 MHz, and whose residual FM is approximately 1 Hz p-p, meets the requirements of a reference for the 2nd L.O. system. The stability properties of this reference oscillator are translated to 2.2

GHz by a type-two frequency servo system as indicated in Fig. 2. The unstable 2.2 GHz oscillator, collector tunable over a ± 1.5 MHz range, is heterodyned with a crystal-derived 2182.5-MHz (FM < 1 Hz p-p) signal. The product at 17.5 (± 1.5) MHz is phase compared

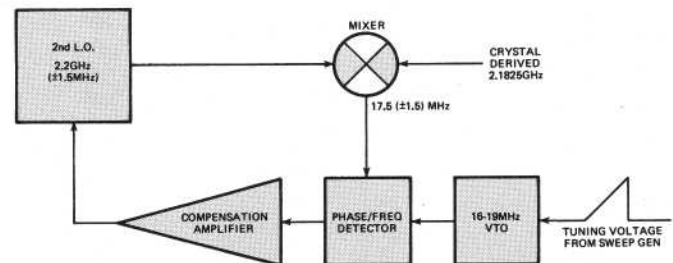

Fig. 2. Second L.O. stabilization system.

with the 16 to 19 MHz reference oscillator and the resultant error signal is amplified and fed back to the collector of the 2.2 GHz oscillator. Thus, the 2.2 GHz L.O. is synthesized in such a manner that it replicates the product of the 16 to 19 MHz oscillator and the 2182.5 MHz crystal-derived source within the bandwidth of the servo system. The complete 2nd L.O. system of the 7L13 exhibits a typical incidental FM of 1 Hz p-p.

A major distinction in the operation of the 2nd L.O. servo system (as opposed to the 1st L.O. loop) is that it is functional in all modes of 7L13 operation. The 2.2 GHz oscillator is never allowed to assume a free running mode and is under the control of the 16 to 19 MHz VTO from the time the instrument is turned on. Consequently, there is no mention of a 2nd L.O. lock mode on the analyzer front panel, and the stabilization of the 2nd L.O. in no way complicates the use of the instrument.

30 Hz Resolution Filter

In order to exploit the extraordinary stability of which the 7L13 local oscillator system is capable, a 30-Hz resolution position was made available to the user. In light of the fact that the widest resolution bandwidth in the instrument is 3 MHz, a center frequency of 10 MHz is chosen for the final IF. In order to keep system complexity to a minimum, this requires that the 30-Hz resolution filter be at 10 MHz as well.

This filter is of the well known lower sideband ladder design (Fig. 3). It employs three quartz resonators whose unloaded Q is in excess of one million and has a nominal 60:6 dB shape factor of 10:1. These resonators, when exposed to temperature variations encountered in the instrument ($0^\circ > 50^\circ\text{C}$), are prone to alter their center frequency by a large fraction of the filter bandwidth. In order that the 30 Hz filter be able to maintain its bandpass characteristics under conditions of varying temperature, the quartz resonators are required to have matched temperature-versus-frequency properties.

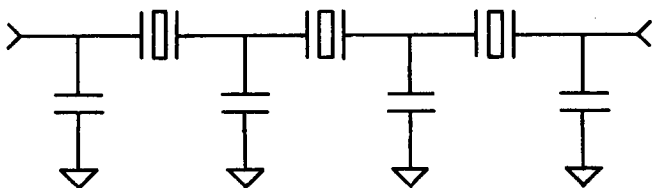

Fig. 3. Simplified circuit of the 30-Hz crystal filter.

Frequency Readout and Tuning

The availability of high linearity (typically .1%) YIG-tuned oscillators prompted the use of a digital frequency readout. This is accomplished by a digital voltmeter (DVM) which monitors the tune voltage of the 1st L.O. The frequency information obtained from the DVM is multiplexed and displayed both on the front panel, by a light-emitting diode display, and on the analyzer screen via the Tektronix CRT READOUT system. This permits the user to measure frequency to an accuracy of $\pm (5 \text{ MHz} + 20\%$ of the frequency span per division); 20% of a division being as close as one can typically judge the signal position, taking into account the effects of observation and the geometry of the display.

Simplification of operation was achieved through the development of a single-knob tuning scheme. Previous analyzers have often had two or more tuning knobs; and depending upon what mode the analyzer was operating in, inadvertent adjustments of the wrong tuning knob could cause severe frequency disturbances in the instrument. This problem is eliminated in the

7L13 through a mechanism employing two magnetic clutches and a self-centering potentiometer. When this system is operated in spans where the 1st L.O. is stabilized, the 2nd L.O. potentiometer clutch is engaged. Starting from a centered position, it prohibits one from achieving lock with the 2nd L.O. tuning control against one stop. Further, access to the 1st L.O. potentiometer is denied the user by disengaging the 1st L.O. potentiometer clutch so that he cannot mistakenly tune the 1st L.O., break lock, and lose his display. When returning to spans which do not require 1st L.O. stabilization, the clutches alternate state returning the 2nd L.O. potentiometer to its centered position and permitting tuning of the 1st L.O.

Convenience Features

We have come to expect such user conveniences as absolute amplitude calibration, freedom from spurious, automatic frequency stabilization, coupled span and resolution controls, display warning indicators and such in our high performance spectrum analyzers; and indeed they are all present in the 7L13. The 7L13 goes a step beyond and introduces the concept of full parameter readout to spectrum analysis (Fig. 4). All pertinent information, i.e., center frequency, resolution bandwidth, span, video filtering, vertical scale factor and power reference level may be viewed at a glance or permanently recorded by a photo of the display.

Performance

The graph of frequency tuning range versus resolution on page 3 shows the performance of the 7L13 and other instruments currently available. As is evident, the 7L13 represents a significant breakthrough in the area of high resolution, high-frequency spectrum analysis. The 7L13 has achieved a high degree of synergism with respect to spectral purity, resolution and drift. The instrument is not limited by the cleanliness of its oscillator system, as is so often the case with other high-frequency analyzers. As Fig. 5 shows, the shape of the 30-Hz resolution filter is clearly defined for well over 60 dB. This performance, familiar to users of low-frequency spectrum analyzers, is uncommon above a few hundred megahertz and due largely to the very conservative 10-Hz FM specification of the 7L13.

Resolution is a significant feature of a spectrum analyzer. Fig. 4 illustrates a 1476-MHz carrier, amplitude modulated at 50-Hz rate with both sidebands distinctly resolved. Fig. 6 shows the same carrier modulated at a 400-Hz rate along with residual 180-Hz line-related modulation on the carrier source 60 dB down.

The question of how long a given stable signal will remain on the display may be resolved by the drift specification. Just how well the 7L13 conforms to its 2

kHz/hr drift specification is evident in Fig. 7. This time-lapse photograph, made at hourly intervals, reveals a total drift of 4 kHz in 6 hours with 1.2 kHz occurring in the first hour.

All of the foregoing performance features of the 7L13 would lose much of their impact if the analyzer were not highly immune to intermodulation distortion. It is this property which in large part determines whether the display on the analyzer is real. Returning to Fig. 5, one can see that, in this 2-tone test at 1555 MHz with 500-Hz tone separation, there are no visible 3rd-order intermodulation products.

In general, it is instruments like the 7L13 which will ease the burden of making critical spectral measurements at high frequencies. And this ability will set the direction for future improvements in communication equipment performance.

Acknowledgments

As with any program embodying the complexity of the 7L13, there are more people involved than can be listed. All should feel a sense of satisfaction from their role in the development of this instrument. The principle contributors, other than the author as project manager, were electrical design: Mike McMahon and Jack Reynolds; mechanical project engineer: Leighton Whitsett; mechanical design: Jack McCabe and Jim Wolf.

¹Telewski, "Freq. Stab. Tech.," TEKSCOPE, Jan. 72, pp. 10-11.

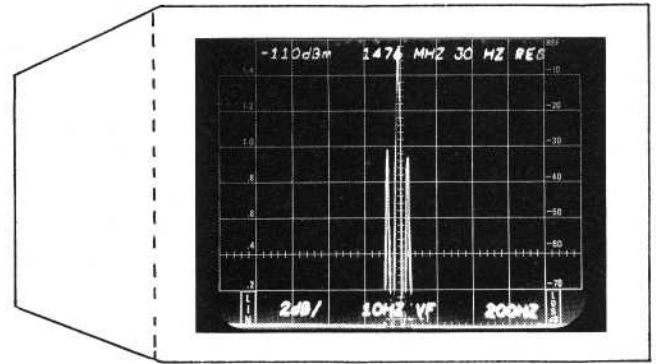

Fig. 4. 1476-MHz carrier modulated at 50 Hz. Note full parameter readout.

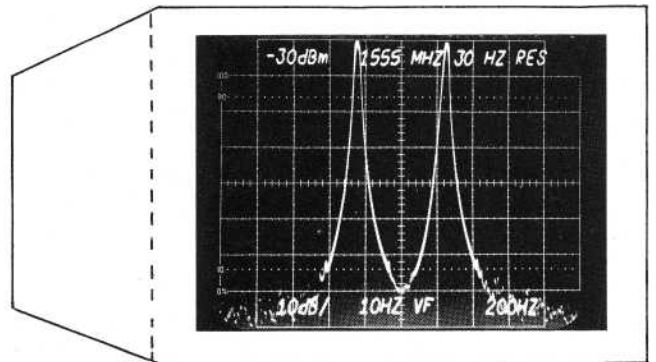

Fig. 5. Two-tone test at 1555 MHz shows freedom from distortion along with spectral purity and resolution filter shape.

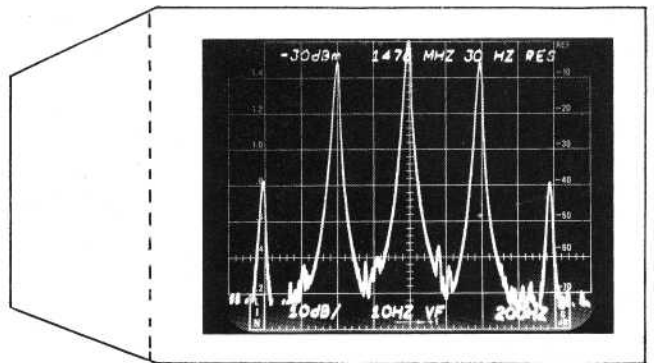

Fig. 6. 1476-MHz carrier 100% AM modulated at a 400-Hz rate.

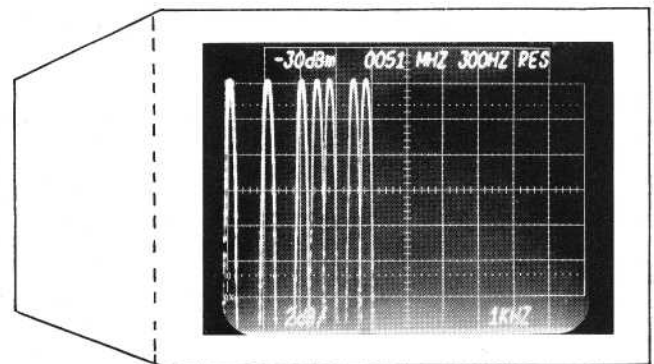

Fig. 7. Time-lapse photo taken over a 6-hour period shows excellent drift characteristics of the 7L13.

CRT READOUT— nicety or necessity?

When the 7000-Series Oscilloscopes were being conceived much discussion centered around a scheme to present alphanumeric information on the CRT along with the waveform. Would the benefits derived justify the engineering effort required? What about the added cost to the customer who didn't need or want readout? These and related questions consumed hours of discussion.

The question of added cost for those not needing readout was neatly resolved by placing the bulk of the readout circuitry on a single printed circuit board. Easily installed or removed, readout could be included at the time the instrument was ordered, or added later at the customer's preference. Only time could adequately answer the question of whether the benefits would justify the effort required.

How It Works

Here, briefly, is how the readout system works. The system uses an electronic character generating circuit which time shares the CRT with the normal scope functions. The characters are formed by a series of X and Y analog currents developed by Character Generating

I.C.'s. A set of 50 different characters are provided, with the capability to add others as the need arises. Included are all of the numerals, most of the alphabet in upper case, the symbols, p , n , μ , m and other special symbols.

To minimize coding complexity an analog coding scheme was developed in which data is encoded by means of resistors and switch closures. This data is generated in the plug-in by connecting these resistors between time-slot pulses and data output lines via the appropriate switch. The coding scheme includes two channels for each plug-in so that dual trace amplifiers and delaying/delayed time bases can be accommodated. A maximum of eight words can be displayed, corresponding to two channels for each of four plug-ins. The position of each word on the CRT is fixed and related to the plug-in from which it comes. Each channel will display one word having up to ten characters. The characters are normally written without redundant spaces, but spaces can be called for in the code if desired. Only those channels in use have their readout displayed.

Some Benefits of Readout

Now, what are some of the benefits afforded by CRT READOUT? To those whose work entailed photographing the waveform a major benefit was immediately apparent. The vertical deflection factors and sweep rates could be recorded right on the film with the

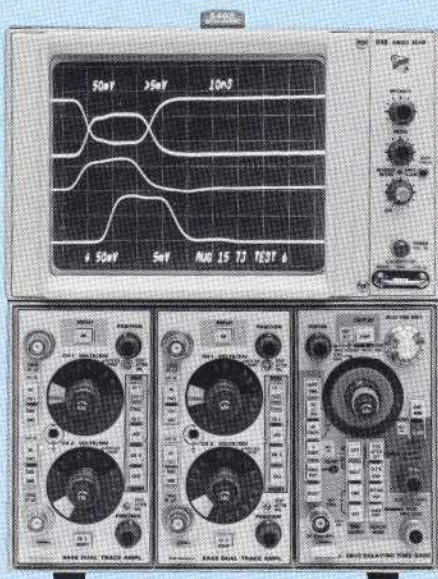

The 5403 Oscilloscope features 60-MHz bandwidth, plug-ins and CRT READOUT.

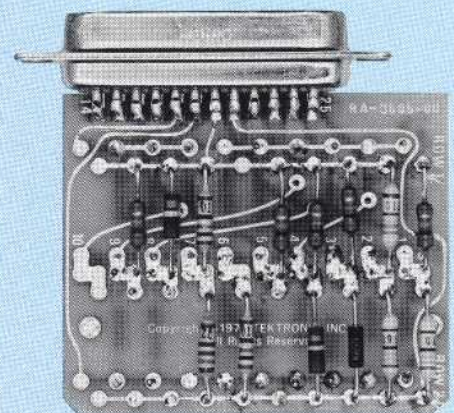
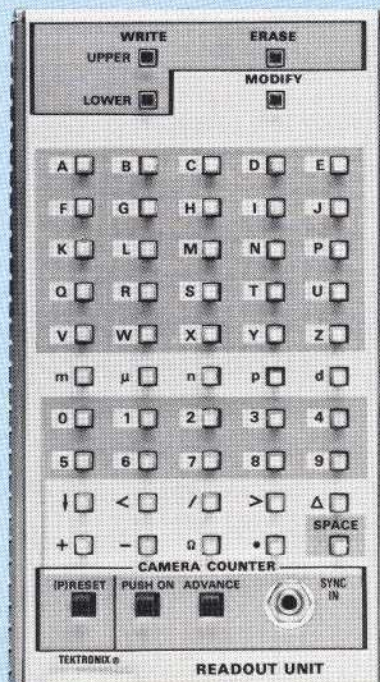
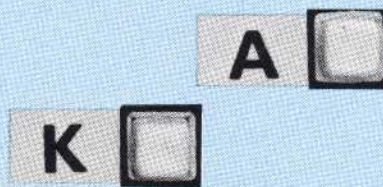

Optional readout programming board for the 5403.



7M13 Readout Unit for the 7000-Series.

displayed waveform. This would be a real convenience and time saver.

Another major benefit was the reduction of operator error in making measurements. More than one piece of research has had to be redone because of faulty data due to probe attenuation or uncalibrated knob settings going unnoticed. With CRT READOUT, the scale factor at the probe tip is automatically indicated when the proper probe is used. An uncalibrated knob setting is denoted by displaying < or > before the reading, e.g., <500 mV.

And then came a major breakthrough in oscilloscope capability. With the introduction of the 7D14 plug-in the oscilloscope became a 500 MHz digital counter¹; the CRT READOUT serving as the display for the counter. And the oscilloscope/counter combination opened the door to previously difficult or impossible measurements. For example, selectively-gated counter measurements could now be made easily and accurately.

Another digital plug-in added digital voltmeter and temperature measuring capabilities. A digital delay plug-in provided a digital delaying time base and the ability to delay by a selected number of events. Spectrum analysis was included with reference level, dB/div, frequency span, resolution and other calibrated parameters all displayed by CRT READOUT.

Another significant measurement capability was introduced with the Digital Processing Oscilloscope. This instrument marries the oscilloscope to a computer or

desk-top calculator. Here, again, CRT READOUT plays a vital role in displaying the parameters of the signal displayed on the screen, which may be considerably different from the signal fed to the oscilloscope input.

Getting a Word In

It didn't take long for customers to voice a need for putting their own words in the readout—information like the date, test number or the engineer's name. To accommodate these needs a "typewriter" plug-in was developed. The 7M13 Readout Unit provides a front-panel keyboard to write alphanumeric and a selection of symbols. Two ten-character words can be written on the CRT screen, one at the top and one at the bottom, in the position associated with the selected plug-in slot.

CRT READOUT In a Low Cost Scope

Because of its proven value, CRT READOUT is also included in the new 5400 Series, a line of low-cost, 60 MHz, plug-in oscilloscopes. Here again provision is made to insert two ten-character words of your own choice in the readout via a 25-pin connector on the rear panel of the scope. An optional plug-in program board makes it easy to build your own words.

Summary

CRT READOUT has proven to be much more than just a convenience, it is the key that opens the door to new measurements for the oscilloscope user. Just what the total benefits will be remains to be determined. We're still discovering new ones right along. 

¹Tekscope, January 1973, "A new world of measurements for the oscilloscope."

TEST 10

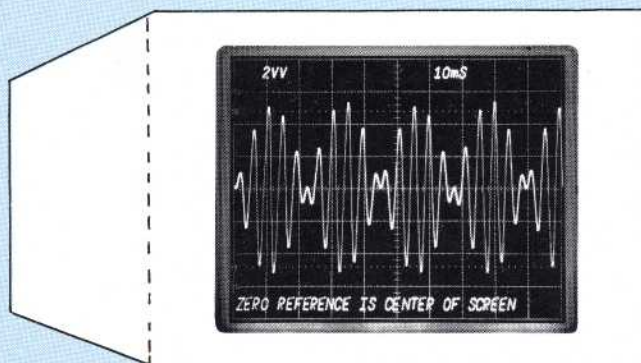

The readout in this photo was programmed by the computer in a Digital Processing Oscilloscope system. The double V indicates the waveform is the resultant of two voltage signals multiplied together.

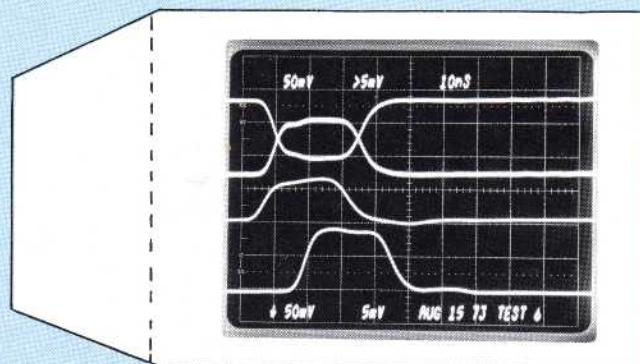

This photo was dated and identified as Test 6 using the optional readout programming board in the 5403.



20mV

Teknique

Flexible disc measurements simplified by digital delay

Signals from a flexible disc and its associated circuitry can be measured using a conventional delaying sweep. However, jitter caused by small speed variations in the rotating disc can make the display difficult to interpret. And when you consider that there may be 100,000 data bits on a single track you can appreciate the difficulty of locating a particular bit. The 7D11 Digital Delay Plug-in eases the task considerably.

The 7D11 can be used in any 7000-Series Oscilloscope having CRT READ-OUT. The plug-in has two basic modes of operation. The first is a Delay-by-Time mode, where a highly accurate internal clock is the time base from which delays are derived. Digital delays from 100 nanoseconds to 1 second,

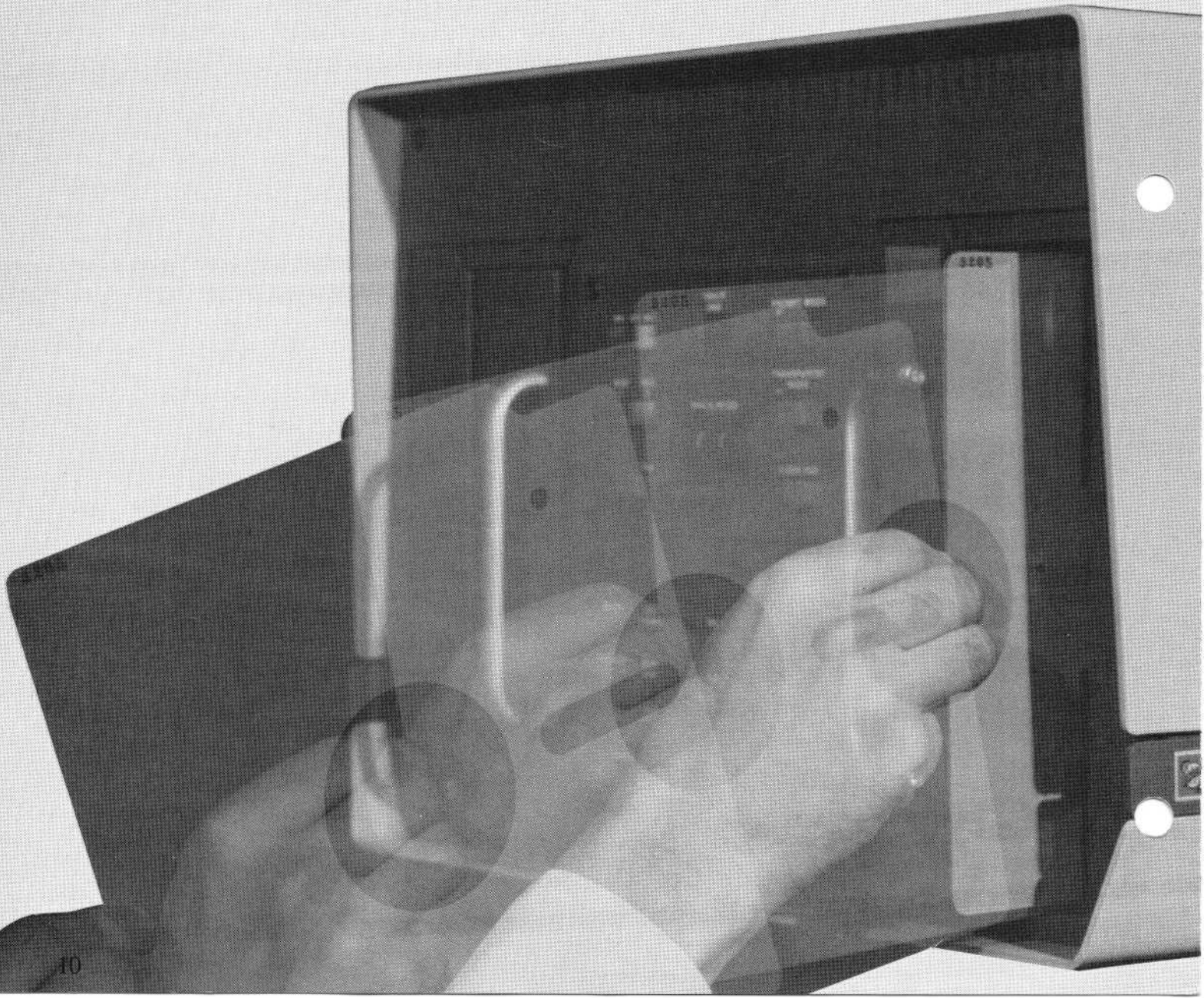

in 100-ns increments, are available in this mode. A helical-controlled analog delay provides an additional 0 to 100 ns of delay providing time delay resolution up to 1 ns.

The second mode of operation, Delay-by-Events, is the mode we're most interested in for this application. In this mode the 7D11 counts arbitrary trigger events, and delivers an output (notifies the delayed sweep) when the preselected number of events is reached. The unit can count events from 1 to 10,000,000 occurring at rates up to 50 MHz, and the events can be periodic, aperiodic, and contain instability such as jitter and drift.

To determine when to start counting the selected number of events, we need to provide a related synchronization pulse to the Events Start Trigger input of the 7D11. This could be the origin pulse, or, perhaps, a sector pulse from the flexible disc, depending on the measurement to be made.

Now let's take a look at some measurements on the flexible disc system. We will be working with the Memorex 651 Flexible Disc Drive. This system uses a disc speed of ≈ 375 RPM. Depending on user requirements, the data may be organized on the disc in multiple records per track (sector) or single record per track (index) format. There are 32 sectors and 64 tracks on the disc. Fig. 1 shows the format for each mode of operation.

The clock frequency used is 250 kHz. The clock is recorded on the track along with the data to permit accurate readout of data with variations in disc speed. Fig. 2 shows the relationship between the index and sector pulses, and the clock and data pulses. The READ

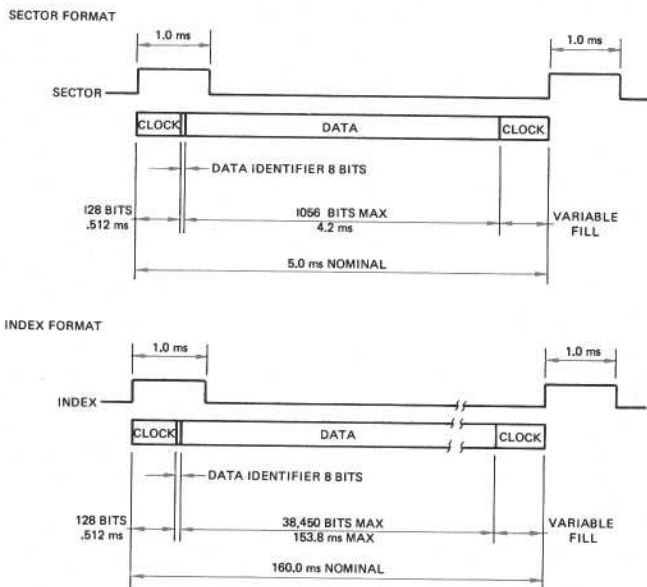

Fig. 1. Formats for data organized for multiple record per track (sector) and single record per track (index).

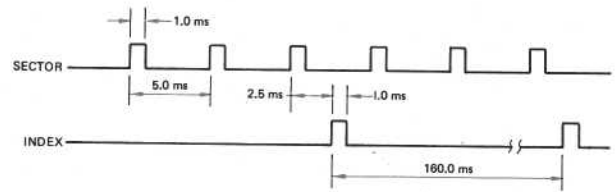

Fig. 2 (a) Timing relationship between the index and sector pulses.

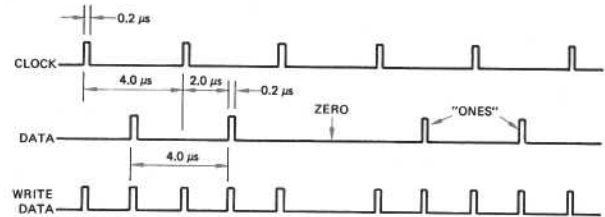

Fig. 2 (b) WRITE data timing and signal waveforms.

head reads the combined clock and data pulses recorded on the disc. The READ logic amplifies and separates them into two outputs: separated clock signals and separated data signals.

Signal Variations from Track to Track

One of the problems encountered in using a disc is the change in amplitude of the signal on the disc as you move from an outer track to an inner track. Fig. 3 (a) is the signal from Track 00 and 3 (b) the signal from Track 63. The bottom waveform in each photo is the analog signal from the READ head; the top waveform is the signal converted to a negative-going TTL-compatible pulse. You will note the events count is 1247. This indicates we have triggered the EVENTS START from one sector pulse and delayed out to permit us to view the start of data in the next sector. The shift of the data to the left in Fig. 3 (b) is due to the fixed spacing between the WRITE and READ heads causing us to miss more of the 136 bits between the start of the sector pulse and the start of data as we move toward the center

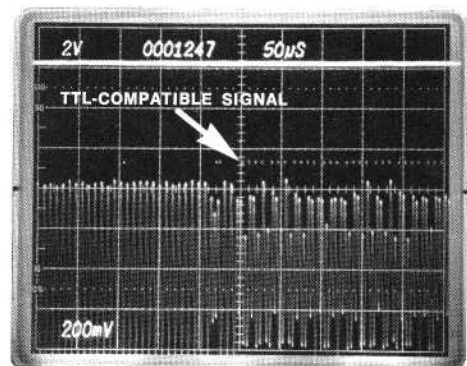

Fig. 3 (a) The lower trace is raw data from the READ head while reading Track 00. Upper trace is signal reconstituted in TTL-compatible format.

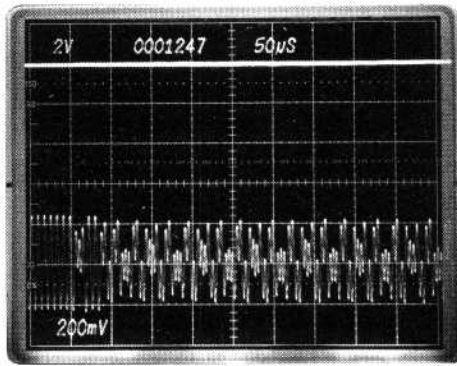

Fig. 3 (b) Same signal source as in Fig. 3(a) read from Track 63.

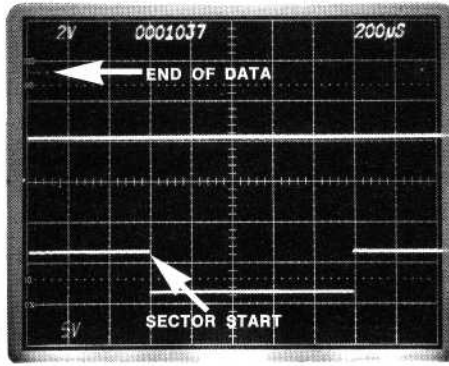

Fig. 5. Time interval from end of data in one sector to start of next sector pulse is easily viewed with the 7D11.

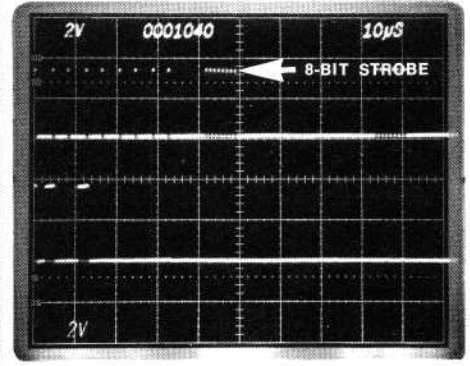

Fig. 7. An events count of 1040 takes us near the end of a sector to view the 8-bit strobe pulse moving data from the shift register to the computer terminal.

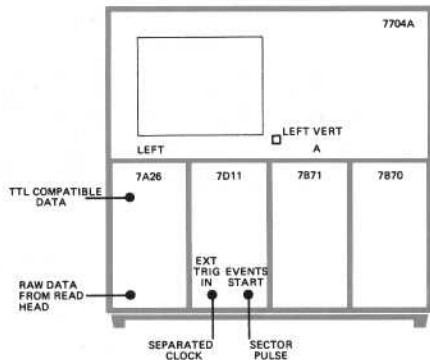

Fig. 4. Setup for making measurements displayed in Figs. 3(a) and 3(b).

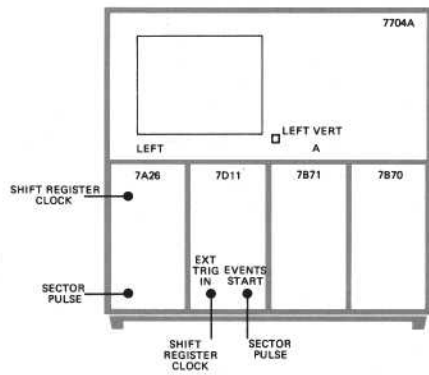

Fig. 6. Setup for making measurement displayed in Fig. 5.

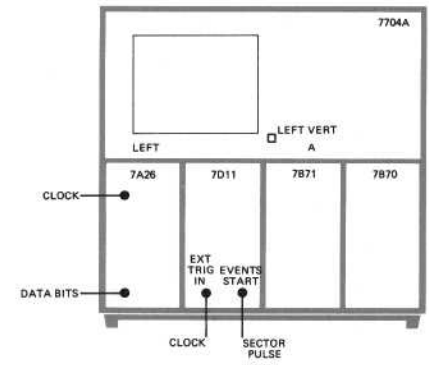

Fig. 8. Setup for making measurement displayed in Fig. 7.

of the disc. The setup to make this measurement is shown in Fig. 4.

Another point of interest in the system is the interval from end of data to the start of the next sector. This is shown in Fig. 5. The upper trace shows the data ending 100 μ s from the start of the sweep. The lower trace shows the next sector pulse starting approximately 500 μ s later. The events count of 1037 was selected to place the leading edge of the sector pulse conveniently on the vertical graticule line. Fig. 6 shows the 7704A setup for this measurement.

The photo in Fig. 7 shows some interesting sets of signals in the system. There are 1048 data bits recorded per sector. An events count of 1040 was selected so we could view the last data in the sector and check for the 8-bit strobing pulse that would transfer the data from the shift register to the computer terminal. The following 8-bit strobe pulse transfers the shift register to the next character. Fig. 8 shows the setup for this display.

Summary

These are just a few examples of the use of the 7D11 Digital Delay unit in making measurements in a flexible disc system. It provides a convenient means of locating and viewing any of the thousands, or in some cases, millions of bits of data present in the disc system.

Other digital plug-ins such as the 7D12 A/D Converter and the 7D15 Universal Counter/Timer are also valuable aids in making accurate voltage and timing measurements in a disc system.

Servicing the 465 portable oscilloscope

The first thing you need to know in servicing a product is how to get the cabinet off. This is less than obvious in much of the packaging used today. You will find it takes a little longer to remove the 465 cabinet than you're accustomed to with the 453. But there's a good reason. The 465 is six pounds lighter than the 453A. And part of the weight reduction is achieved by using the cabinet to mechanically strengthen the package. This is accomplished by extending the cabinet slightly beyond the rear panel of the instrument. When the rear ring assembly, with the feet attached, is installed and tightened down it compresses the cabinet and pulls on the main chassis member, stressing both of them. This stress adds strength to the package.

The best procedure for removing the cabinet is to put the front cover in place, set the instrument on the front cover and remove the six screws holding the rear ring assembly. Four of these serve as mounting screws for the rear feet. The cabinet is then slid off vertically. When replacing the cabinet on

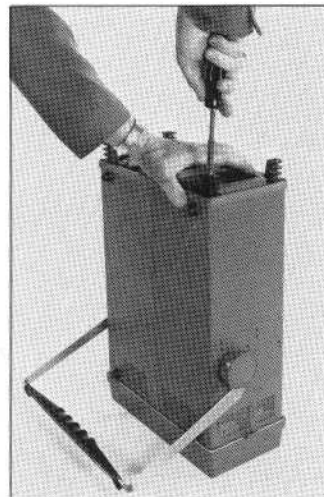
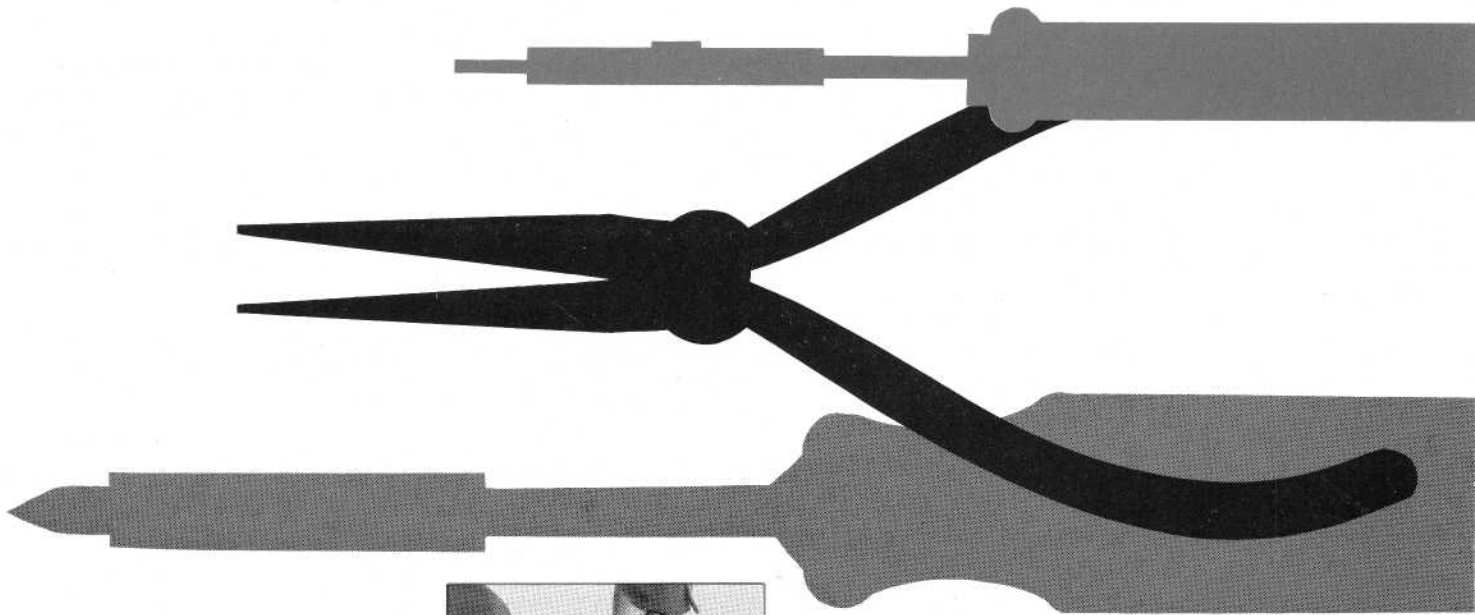

Fig. 1. The 465 cabinet is removed by loosening six screws on the rear panel.

earlier instruments, take care that the cabinet clears the components on the trigger-view board. In later instruments this circuitry is laid out on the trigger board.

It would be well at this point to make sure the instruction manual you are using matches the instrument you are servicing. Tektronix has always followed the policy of modifying the circuitry to improve performance and reliability as the occasion arises. Modification information is added in the back of the manual to keep it current with the instruments being shipped.

The Power Supplies

When a problem area is not readily apparent from front panel indications, a good place to start troubleshooting is the power supply. Temporarily-high line voltage sometimes causes the line fuse to blow. In instruments below SN B080000, circuits powered from the +120 V supply are protected from high line voltage by Q54 (Q1514 in some instruments). Should the line voltage exceed a given level, Q54 conducts placing a short across the transformer secondary and blowing the line fuse. When replacing the fuse you should use the specified value to prevent damage to the circuits protected by Q54. If the line voltage in your facility tends to fluctuate in the upward direction you may set the line Range Selector Switch Bar to the high position. The front-panel low-line light will come on should the line voltage fall below the lower limit of the regulating range selected.

Another problem you may encounter in the low-voltage supply is CR1512 shorting and taking out C1542. The cure for this is to remove CR1512. Do not discard this diode as it can be used in a modification to improve the high-voltage supply reliability.

The high-voltage supply is often difficult for many of us to troubleshoot. Here are some hints on servicing these circuits in the 465. The first step is to isolate the problem area. There are three major areas of concern: the high-voltage oscillator and DC-error amplifier, the over-voltage protection circuit, and the secondary load including the CRT and the high-voltage multiplier. By disconnecting the appropriate circuit the high voltage should come up. Try the following sequence:

1. Remove the CRT socket — this eliminates the CRT.
2. Disconnect CR1412—this eliminates the over-voltage protection circuit.
3. Remove Q1416 and place an 820 Ω to 1 k Ω resistor between the collector and emitter pins. This allows \approx 8 ma of turn-on bias current to start the oscillator. If this does nothing, replace C1416 and C1419. (C1419 should be replaced anytime the high-voltage oscillator Q1418 is shorted.)

If at this point the high-voltage reading at TP1423 is \approx -400 volts, the high-voltage multiplier is most likely defective. In newer instruments this can be quickly checked by lifting the dummy resistor that connects the multiplier ground. Arcing from this point to adjacent circuitry sometimes occurs when this ground strap is lifted. For earlier instruments you will have to remove the vertical preamp board and the multiplier cover to get to the high-voltage transformer and multiplier connection. Lift the transformer lead and CR1421 from the mounting post on the multiplier, connect them together and dress them away from the mounting post to prevent arcing across. If the negative high-voltage supply comes up now, the multiplier is defective. A defective multiplier will also sometimes cause high-voltage fuse F1419 to blow.

Another condition that can effect the high voltage is leakage in diodes CR1482, CR1483, CR1487 or CR1488. These are in the CRT grid bias supply and can turn the beam on hard or turn it off so you have no intensity. Another point to check is pin 12 on the CRT; this should be +150 V. Leakage in C1427 may pull this point down in some instruments between SN B080000 and B130000.

Check to see whether R1427, which parallels C1427, has a zener diode in parallel with it. If not, your instrument doesn't have the high-voltage reliability modification and it should be installed. It consists of adding or changing just four components:

1. CR1476 located near Q1474 should be replaced by CR1512 which you removed from the low-voltage supply.
2. A 0.1 μ F, 200 V capacitor should be added from the cathode of CR1476 to ground.
3. A 180 V zener, Tektronix part number 152-0289-00, should be paralleled with R1427 with the cathode to ground.
4. Lift the cathode end of CR1427 and add a 1.8 k Ω , $\frac{1}{4}$ W, 5% resistor between the cathode and the point to which it was soldered on the circuit board. This completes the modification.

The Sweep Circuit

The sweep circuit contains several feedback circuits and is difficult to troubleshoot unless you break the feedback loop. A convenient means of doing this is to pull the Disconnect Amplifier, Q1024. This causes one sweep to be generated and often provides a rapid clue as to what portion of the circuitry is in trouble.

The horizontal amplifier circuitry is push-pull and can be checked by the usual method of shorting the two sides by means of a jumper. Another useful technique is to swap transistors in each stage and see if the problem changes sides accordingly.

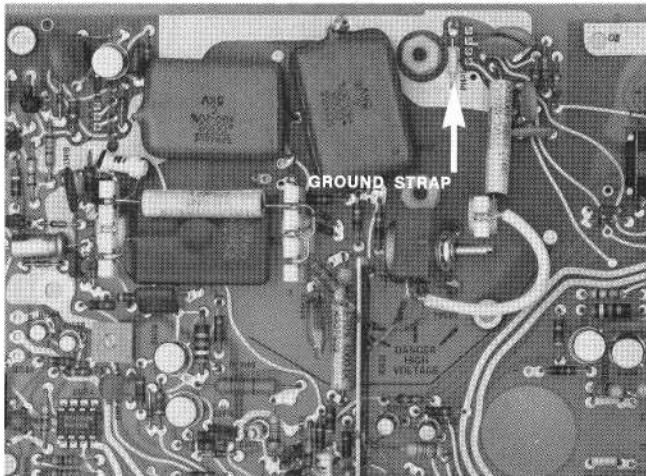

Fig. 2. A portion of the interface board showing location of the high voltage multiplier ground strap and other components.

The Vertical Amplifier

If you have occasion to service several 465's you may note that some units have an integrated circuit output amplifier while others use discrete components. The front panel BEAM FINDER control provides a rapid means of detecting trouble in this circuitry. Pressing the BEAM FINDER button should bring the trace on-screen vertically. If it doesn't, look for the problem in the output amplifier circuitry.

Moving to the preamp, one of the more elusive problems you may encounter is an intermittent contact between transistors and their sockets. What usually happens, is the transistor is pulled from the socket, tested and found to be O.K. When the transistor is put back into the socket, the problem disappears. The basic cause seems to be a tendency for the contacts to "wick up" rosin and solder during the automatic flow soldering process. A change has been made in manufacturing procedures to overcome this tendency. If you suspect that you have this problem, you can clean the socket with isopropyl alcohol, using a wire to loosen the rosin inside. A camel hair brush works best in applying the isopropyl and a syringe is handy for blowing out dirt particles.

Another question often asked is how to get the transistor pairs used in the preamp, properly mounted in their heat sinks. The easiest way is to first insert the transistors in their sockets and then slip the heat sink loosely over them. Next, extract the transistors and heat sink together by gripping the heat sink firmly with a pair of pliers, and pulling. Continue to hold firmly with the pliers while tightening the screw in the heat sink. Then reinsert the transistors in their sockets.

While we're in the preamp area, another condition sometimes occurs that appears to be drift in the vertical attenuator compensation. In most cases this results from the technique used in making the adjustment. The

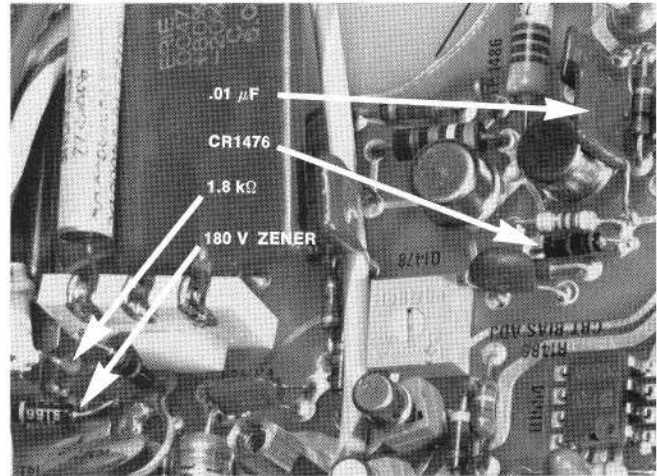

Fig. 3. A portion of the interface board showing the high-voltage reliability modification installed.

compensation capacitors have a spring that provides tension. When making the adjustment it will help to "rock it in" to remove the torque portion of the spring tension. Just overshoot the desired setting a little and then back off to the proper point.

Mechanical Considerations

One of the unique components used in the 465 is the cam switch developed by Tektronix. These are relatively trouble-free but occasionally require cleaning of the contacts. Isopropyl can be used for this purpose. Here again you will find a camel hair brush handy. Do not use cotton swabs as they are prone to snag on contacts, damaging them.

Special care is needed when working on the vertical attenuator cam switches. The polyphenylene oxide boards are brittle and easily damaged by using too much force when tightening the screws holding the cam switch. Two fingers on the screwdriver will provide enough torque. These boards also are easily damaged by heat so when soldering on them, use a small iron and get on and off quickly.

Cleaning the Instrument

The same procedures and materials used to clean other Tektronix instruments can be used for the 465. For washing the entire instrument a solution of one part Kelite to twenty parts water can be used. For spot cleaning, especially in the area of the vertical attenuator boards, you should use isopropyl alcohol. Carbon-based solvents will damage the polyphenylene oxide boards used for the attenuators. This is also important to keep in mind when using spray coolants in this area. ☞

INSTRUMENTS FOR SALE

360 Indicator, 126 Power Supply with cabinet, \$145. Robert Kaplan, Ebasco Services Inc., 2 Rector St., New York, NY 10006. (212) 344-4400.

317, (2) 321A's. Lindsay Acuff, Cleveland Electric Co., 557 Marietta St. 1 N.W., Atlanta, GA. 30313. (404) 524-8422.

434 w/cart and accessories, unused. Roy Madison, 1606 18th Ave., PO Box 1088, Tuscaloosa, AL 35401. (205) 345-2990.

453A MOD127C in mint condition. \$1750. Charles Boster, Box 2376, Apt. H-203, 635 Baker St., Costa Mesa, CA 92626. (714) 557-0792.

453, three years old, \$1250. Fred Lindsey, Vallejo, CA. After 5:00 PM. (707) 644-7037. 503, good condition. \$200. Ray Lefebvre, Electrical Eng., Louisiana State Univ., Baton Rouge, LA 70803. (504) 388-5241.

514D (7), 514AD, 511AD, 531 fair condition. Best offer. W. A. McConnell, Dutchess Community College, Poughkeepsie, NY 12601. (914) 471-4500, Ext. 268.

517, less power supply. Will trade for 530/540 Series vertical plug-in. Dr. Shuster, Box U125, University of Conn., Storrs, Conn. 06268.

517A w/power supply, no cables. As is \$135. Type B plug-in, 122 preamp, 280 trigger. E.C. Fether, 8713 Marble Dr., El Paso, TX 79904. (915) 755-0226.

527 Waveform Monitor, MOD132. Thomas O'Brien, 2194 Coker Ave., Charleston, SC 29412. (803) 556-8824 (home), (803) 792-3030 (business).

531A, \$400; 533, \$450; B, \$50; CA, \$165. Exc. condition. Kurt Dinsmore, Box 67, Richardson, TX 75080. (214) 271-2431 or (214) 238-0591, evenings.

543B, 1A2 plug-in, good cond. \$800 or best offer. Pat Young, (415) 654-6855.

545A w/cart, 2 ea. Best offer. Neria Yomtoubian, Master Specialties, 1640 Monrovia, Costa Mesa, CA 92627. (714) 642-2427, Ext. 218.

545A, RM 35A, 1A1, CA and two ea. 541's. Howard Baugh, Wyle Computer Products, Inc., 128 Maryland St., El Segundo, CA. (213) 678-4251.

547, 1A1, 1A5, like new, best offer. Paul Fincik, Automation Sys., Inc., 7031 Marcelle St., Paramount, CA 90723. (213) 634-5810.

INSTRUMENTS FOR SALE

549, 1A1. Maurice Bruneau, Nashua Corp., 44 Franklin St., Nashua, NH 03060. (603) 883-7711, Ext. 506.

549, \$1000. Mike Surratt, OECO Corp., 712 S.E. Hawthorne, Portland, OR 97214. (503) 232-0161, Ext. 349.

561A/3A75/2B67, like new. Jack Gerylo, 5707 Santa Fe St., San Diego, CA 92109. (714) 453-4013.

661/5T4/4S1, clean, like new. Want Collins 30S1 linear or equiv. dollar value. Ed Valentine, Top-O-Hill Rd., Wappingers Falls, NY 12590. (914) 297-3461.

661/4S1/5T1, excellent cond. Sell or trade for real time scope around 10 MHz. George Capasso, 25 Quarry Dr., Wappingers Falls, NY 12590. (914) 297-7538.

3S7, 3T7 TDR plug-ins, never used. \$950. Art Eberle, Columbia Gas Systems, 1600 Dublin Rd., Columbus, OH 43212. (614) 486-3681, Ext. 461.

2B67 and 3A74 to trade for 3B3 or 3B4 and 3A6. H. L. Bezell, 104 Key West Dr., Charlottesville, VA 22901.

202-2 Cart, \$100; E Plug-in, \$60. Neil Pering, 2803 Kipling, Palo Alto, CA (415) 321-2714 or Walt Sonnenstuhl, 41 Moraga Way, Orinda, CA 94563.

C-31 Camera, excellent condition. Reasonable. Mr. Sinclair, 160 E. 84th St., N.Y., NY 10028. (516) 234-0200 (days); (212) 861-9862 (evenings).

549 w/1A1. Bob Schmidhammer, Metric Data System, Rochester, NY. (716) 325-6550.

515, good condition, \$300. Hal Greenlee, 430 Island Beach Blvd., Merritt Island, FL 32952. (305) 853-9991 (business), 636-0805, (home).

R5103N/D12, three 5A24N's. Almost new. Best offer. Maurice Asa, Box 2947, Rockridge Station, Oakland, CA 94618. (415) 654-2665.

2601, 26A1, 26A2, 26G3. John Foster, N/J Electronics, P.O. Box 577, Laramie, WY 82071.

211 (15). Richard Strickler, Storage Technology Corp., 2270 S. 88th St., Louisville, CO 80027. (303) 666-6581.

TELEQUIPMENT DM64, new. \$1,000 or best offer. Alpha Labs, Inc., 2115 No. Piedras, El Paso, TX 79930. (915) 566-2927.

INSTRUMENTS FOR SALE

C-27R Camera, Polaroid roll film back and bezel. Good condition. \$375. (203) 848-8614 after 7:00 P.M.

546 (2), like new, \$1250 ea.; 543 w/CA, \$750. Consider good cash offer. Ivan Sundstrom, 695 E. 43rd, Eugene, OR 97405. (503) 686-2380 evenings, weekends.

531A/CA/D. Wayne Siebern, St. Joseph Power & Light, 520 Francis, St. Joseph, MO. (816) 238-0025.

516, excellent condition. \$500. Dave Friedman. (213) 837-3089.

564B w/2B67, 3A6, scope cart and C-27 Camera, new. Also 585A with 53/54G and scope cart. 661 w/4S1 and 5T1 and scope cart. Excellent condition. Chemistry Dept., Univ. of Bridgeport. (203) 384-0711, Ext. 382.

(3) 5103's. \$450 ea. or best offer. Also (3) 5B10N's, (3) 5A18N's and (1) 5A21N. Jon Orloff, Elektros Inc., 10500 S.W. Cascade Dr., Tigard, OR 97223. (503) 620-2830.

INSTRUMENTS WANTED

160 Power Supply in working condition. Prof. Winthrop Smith, U46 University of Connecticut, Storrs, CT. (203) 486-4918. 321A. Marvin Loftness, 115 W. 20th, Olympia, WA 98501. (206) 357-8336.

422, 465 or any portable scope. H. O. Van Zandt, 18 Chandelle Dr., Hampshire, IL 60140. (312) 683-3690.

453 or 454. S. L. Shannon, G.T.W.R.R. Radio Shop, 105 Hampton, Battle Creek, MI 49016.

520 or 520A. Al Dodds, Applied Video Electronics, Inc., P.O. Box 25, Brunswick, OH 44212. (216) 225-4443.

555 with time bases, C-12 or C-27 Cameras. A. C. Smith, Jr., High Voltage Lab., Cornell Univ., 909 Mitchell St., Ithaca, NY 14850.

2-2A60's. Darwin Carner, General Electric, 3001 E. Lake Rd., Erie, PA 16501. (814) 455-5466, Ext. 2635.

2A63. Roy Schreffler, Box 531, Knox, PA 16232.

Plug-in vertical amplifiers for TELEQUIPMENT D43 scope. Wm. A. Richards, 46 Alderwood Lane, Rochester, NY 14615.

TELEQUIPMENT D67, D85. 453 or 422. Also 3B3 plug-in. Hal Greenlee, 430 Island Beach Blvd., Merritt Island, FL 32952. (305) 853-9991 (business), 636-0805 (home).



TEKSCOPE



TEKTRONIX®

committed to
technical excellence

Customer Information from Tektronix, Inc.,
Beaverton, Oregon 97077

Editor: Gordon Allison

Contents

2 A big step forward for direct-view storage.

The new 7834 Storage Oscilloscope combines 400 MHz bandwidth and 2500 cm/ μ s stored writing speed in a four plug-in 7000 Series mainframe to bring you a new high in performance and versatility in a general purpose oscilloscope.

6 Counter and oscilloscope combination makes difficult measurements.

Selective counter measurements are easy to make using an oscilloscope with delaying sweep and dual trace algebraic add functions.

11 Testing three-terminal regulators with a curve tracer.

A 577/178 Curve Tracer provides an ideal answer to the need for performing short run incoming inspection tests, circuit design, or device characterization of three-terminal regulators.

14 Tektronix products get dirty, too!

Part II describes "dry cleaning" techniques for those users who can't release their instruments long enough for a thorough wash job.

Cover: Dr. Gail Massey of Oregon Graduate Center studies a YAG laser pulse stored and displayed on the 400 MHz 7834 Storage Oscilloscope.

Copyright © 1977, Tektronix, Inc. All rights reserved. U.S.A. and Foreign Products of Tektronix, Inc. are covered by U.S.A. and Foreign Patents and/or Patents Pending. TEKTRONIX, TEK, SCOPE-MOBILE, TELEQUIPMENT and  are registered trademarks of Tektronix, Inc. Printed in U.S.A.



Jerry Rogers

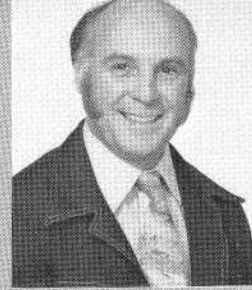

Ken Hawken

A big step forward for direct-view storage

State of the art direct-view storage takes a big step forward with the introduction of the TEKTRONIX 7834 Storage Oscilloscope. Up to now the maximum stored writing speed has been 1000 cm/ μ s in the 7633 plug-in oscilloscope and 1350 cm/ μ s in the 466 portable. Both are 100 MHz instruments.

The new writing speed mark is 2500 cm/ μ s, and it's coupled with 400 MHz bandwidth in the new 7834. This means you can now capture a 3.5 cm high, single-event risetime of 1.4 ns.

The 7834 is a general-purpose laboratory oscilloscope with all of the synergistic measurement power produced by the four plug-in capability of the 7000 Series. For example, real time and spectrum analyzer plug-ins can be housed to simultaneously present both time and frequency domain displays for a given signal. Using the 7834's variable persistence storage mode, a steady display of the time domain can be viewed while observing slow changes in the spectral content. In another configuration, logic analyzer and real time plug-ins can be combined to zero in on a logic fault and then display that fault in real time, even though it may occur only once.

Multimode storage

The 7834 features multimode storage—bistable, variable persistence, and fast modes for each, pioneered in the 7623 a few short years ago.

The bistable storage-display is characterized by having two intensity levels—the stored-image intensity and the background level. There are two such modes: BISTABLE and FAST BISTABLE. The chief advantage of both of these modes is long view-time. Once an image is

stored, it can be viewed for an extended period. The BISTABLE mode is the simplest of all to use, with no adjustments for storage sensitivity other than the intensity control. Also, with a high resistance to blooming, this mode is unsurpassed for storing extremely low-frequency events that require a slow-moving spot on the crt. This mode, therefore, can capture waveforms with extreme differences in spot movement speed. The chief limitation is writing speed. The FAST BISTABLE mode also is resistant to blooming and overcomes the low writing-speed limitation. It is the second fastest mode of the instrument, with a writing speed of 350 cm/ μ s in reduced scan, and is useful in capturing single-shot information.

Variable-persistence storage displays are characterized by controllable persistence (the rate at which the stored display fades). Typically, this rate of fading may be adjusted from 1 or 2 seconds to well over a minute. There are two such modes: VARIABLE PERSISTENCE and FAST VARIABLE PERSISTENCE. The chief advantage of these modes is high writing speed. When the storage controls are optimized, writing speed is many times greater than in the corresponding bistable modes. The storage controls may also be adjusted to provide high-contrast displays that are especially advantageous for photography. In both variable persistence modes, view time (the length of time a stored trace is distinguishable from the background) is less than in the bistable modes, and is shortest of all when adjusted for highest writing speed. View time can be increased by using the SAVE mode as on other storage oscilloscopes.

The VARIABLE PERSISTENCE mode in the 7834 can convert a dim display of a fast, low-repetition-rate signal, into a bright, flicker-free display for easy viewing of signals that are beyond the display capability of non-storage instruments. By varying the persistence (or rate of fading), the best compromise can be reached between lack of flicker and ability to follow changes in the waveform.

The FAST VARIABLE PERSISTENCE mode provides the highest writing speed of all, 2500 cm/ μ s in reduced scan. This mode is most useful for capturing high-speed single-shot events such as fast rise pulses encountered in laser fusion research, destructive testing, and high speed computer development, that occur only once, or at very low rep-rates at best. The 7834 offers an unprecedented ability to display these pulses.

New operational features

The 7834 has several features not found on other storage oscilloscopes. These features add convenience and flexibility. For example, the MULTI-TRACE DELAY control extends the usefulness of the transfer-storage modes (FAST BISTABLE and FAST VARIABLE PERSISTENCE). When a time base operates in a repetitive

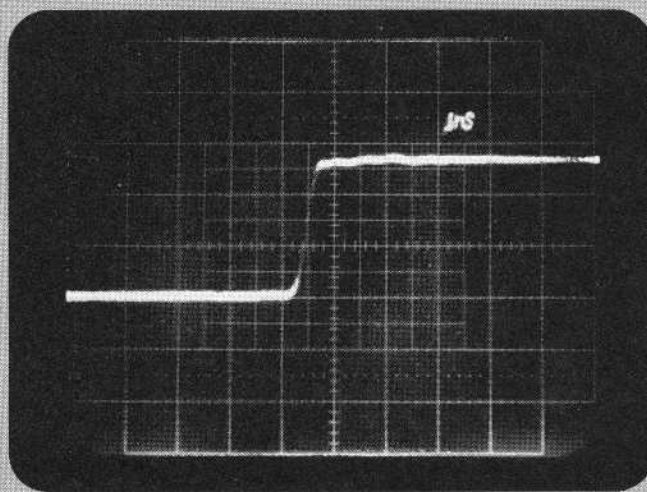

Fig. 1. Stored display of a single-shot, fast rise time signal.

manner (rather than single sweep), this control varies the display time between successive sweeps. An "infinite" position provides the same effect as single-sweep operation. One application of the multi-trace delay control is in making calibration adjustments. The operator simply sets the delay equal to the time required to change an adjustment. The new result is then automatically displayed (along with the old), freeing the operator from manually resetting the oscilloscope time base for each trace. Another application is to store a periodic waveform that occurs in a longer sequence of events. The multi-trace delay may be adjusted to blank out unwanted events and allow triggering only on the desired waveform.

The Remote-Storage inputs give the user control over several essential storage functions. With Remote Erase, Reset, and the new Remote Save inputs, the operator can conveniently conduct experiments at a distance from the oscilloscope, or control these functions automatically from other equipment.

A new Remote-Storage Gate input provides the user additional capability in the fast-storage modes. Use of this input, along with a second time base, permits capturing several closely spaced events on the same display, an ability not possible in fast-storage modes on previous instruments.

Two types of Auto Erase are available in the 7834. One is an adjustable periodic function that erases on a regular basis whether or not a stored display is present. The other type provides an adjustable display time after each stored event, and will not erase unless the time base has been triggered.

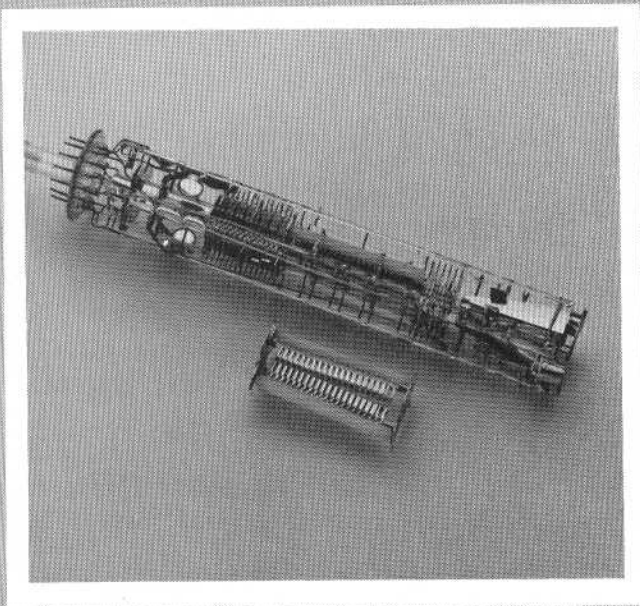

Fig. 2. Electron gun structure of the 7834 cathode ray tube. The vertical deflection structure, with the shield removed, is shown below the vertical deflection portion of the gun.

Gated or Free Run readout selection is located on the front panel. This feature is especially convenient when switching between storage (where Gated is often used) and non-storage operation (where Free Run is typically more desirable). Previously, the Gated/Free Run switch had been located inside the mainframe, requiring removal of a sidecover to change modes.

Fast X-Y storage is possible in the 7834 because of a horizontal-mode selector switch and the availability of two horizontal plug-in compartments. Previously, X-Y storage was possible only in the slower, or non-transfer, storage modes.

Cathode ray tube

Much of the 7834's advanced performance is achieved through extending the capabilities of the cathode-ray tube (crt) to provide multi-mode storage. Both bistable and variable persistence designs are incorporated into the crt. In addition, a new focusing structure and improved electron-gun design are used to reach the high stored writing-rate. Further, a more sensitive deflection system was needed to reach the 400-MHz design goal for the vertical system passband.

In designing the crt, we built upon the experience gained with the 7633 transfer-storage tube. Transfer storage is the technique whereby two storage meshes are used to capture and display information, especially fast transients.

The writing beam stores an image on a highly sensitive short-view-time target. The image is then transferred to the second storage mesh, which has lower sensitivity but much longer view times. This second mesh

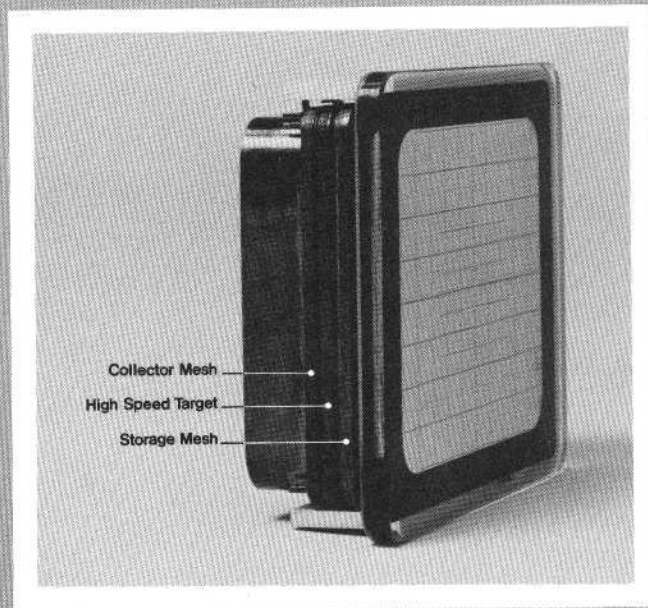

Fig. 3. A cutaway of the front portion of the 7834 cathode ray tube, showing the three-mesh structure used to achieve transfer storage.

can be operated in either a bistable or a variable persistence mode.¹

A number of performance improvements were required of the crt to be suitable for a 400-MHz storage oscilloscope. These include both improved gun design and storage uniformity.

The gun design changes include a traveling-wave deflection system similar to that used in the TEKTRONIX 7904 Oscilloscope, the deflection sensitivity is improved to 1.7 V/cm/kV (a 50% improvement over the 7633 crt). To obtain a faster stored writing speed, an improved gun system was designed to deliver greater charge density to the target. The gun voltage was increased to improve the secondary-emission yield at the target and to reduce the space charge spreading of the writing beam. Independent X- and Y- focusing systems were designed, together with a vertical-only scan expansion lens, to obtain the required vertical-deflection sensitivity. The new focusing system results in improved trace width for the same beam current. More sensitive horizontal plates were designed to help in obtaining faster sweep speeds. An overall improvement in gun performance of 2.5 times was realized.

Additional gain in writing speed was obtained by improving the background uniformity of the display. Since a trace that will store on one part of the target may not store on another part, the writing speed specifications are quoted for the slowest portion of the target within the display area. To this end, the flood-gun collimation system was computer designed to improve landing characteristics and consequently improve background uniformity. This typically reduced the ratio

between reduced scan and full scan variable persistence writing speeds from 8:1 to 6:1. Some performance gains over the previous fast-storage crt used in the 7633 are shown in Figure 4. This shows the typical writing speed expressed as tracewidths/second as a function of Intensity for the two fastest storage modes (variable persistence fast and bistable fast, in reduced scan). The reduced-scan mode of operation typically results in an eight-times improvement in writing speed over the full scan operation, due to the increased gun voltage and the reduced effect of target uniformity on writing speed. In the fastest mode, the writing speed approaches 10^{11} tracewidths/second. This compares with the photographic writing speed of the 7904. These stored traces are viewable for tens of seconds and are easily photographed.

Writing speed

Unless someone is very familiar with storage terminology, a writing speed specification may not be very meaningful except in a relative sense, where one storage oscilloscope is better than another. Therefore, a review of some basic storage concepts will better relate what the high performance of the 7834 does for your measurement needs. Writing speed is defined as the highest rate of spot movement on the crt face that will leave behind a stored image. Spot movement that is faster than writing speed will not leave an image, resulting in step response displays with no vertical edge, or sine wave displays with the center missing.

To be more precise, writing speed can be related to common waveforms by the equations:

$$(1) WS = \pi fA$$

$$(2) WS = \frac{kA}{T_r}$$

Equation (1) is for a sine wave of frequency, f , in megahertz, and peak-to-peak amplitude, A , in centimeters, yielding writing speed in $\text{cm}/\mu\text{s}$. Thus, a writing speed of $2500 \text{ cm}/\mu\text{s}$ will store a 250 MHz sinewave with 3.2 cm peak-to-peak amplitude.

Equation (2) describes writing speed in terms of the vertical edge of a pulse or step response. The value of k ranges from 0.8 for a linear ramp, to 2.2 for a single-pole rc response. A value of 1.0 applies to a Gaussian or typical step response. T_r is the 10-90% rise time in μs and A is the amplitude in cm, to yield writing speed in $\text{cm}/\mu\text{s}$. Thus, a writing speed of $2500 \text{ cm}/\mu\text{s}$ will store a 2.5 cm Gaussian step response with 1-ns rise time.

The 7834 achieves its maximum specified writing speed of $2500 \text{ cm}/\mu\text{s}$ in a reduced scan mode, with 0.45 cm divisions. Writing speed in divisions is calculated by dividing by 0.45: thus, a 3.2-cm sine wave will be 7.1 divisions peak-to-peak. In these relationships, horizontal movement is not taken into account. However, for beam movement of more than three vertical divisions

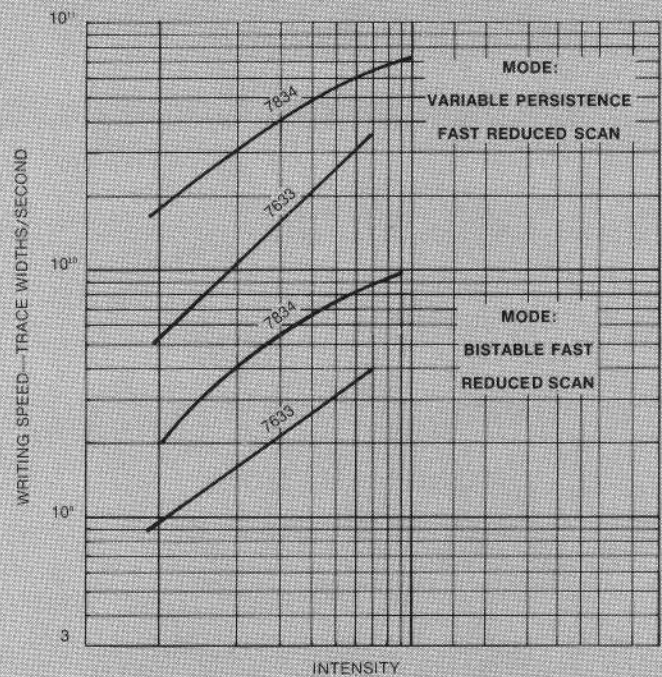

Fig. 4. Relative performance of the 7834 and 7633 Storage Oscilloscopes are shown in this graph of stored writing speed as a function of Intensity level setting.

for every horizontal division, the effect of horizontal movement is less than five percent, and can usually be neglected.

General design features

Construction of the 7834 is much like the modular 7704A. The instrument is divided into two main modules that may be easily separated for ease of service. Like other 7000 Series four-plug-in mainframes, the 7834 has a high-efficiency power supply. This supply runs cooler and is much lighter than a conventional regulated supply. It is also more immune to electro-magnetic interference through the power line. The 7834 circuitry is highly protected from overloads such as a spurious short between various crt electrodes.

Acknowledgments

Project Engineer Chuck Scott directed the 7834 design. Electrical design was by John Durecka, Dave Morgan, Joe Peter and Jerry Rogers. Mark Anderson did the mechanical design. Gene Andrews was Project Manager.

The 7834 CRT development was headed by Project Manager Pete Perkins who did the collimation studies. Ken Hawken was CRT Project Engineer and Steve Blazo did the new CRT gun design. Dave Coffey did the CRT Manufacturing Engineering.

Marketing planning was done by Dave McCullough, and Mike Hurley is the Marketing Program Supervisor. Dwayne Wolfe is Manufacturing Manager.

1 See Tekscope July 1972



Emory Harry

Counter and oscilloscope combination makes difficult measurements

Modern electronic counters are versatile, accurate instruments used in a wide variety of applications. However, many measurements are difficult or even impossible to make with conventional counters. Here are a few examples:

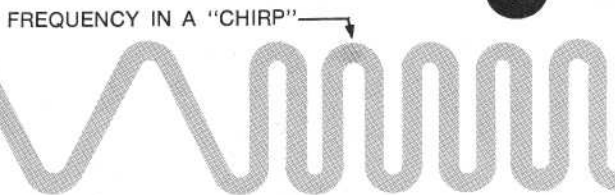
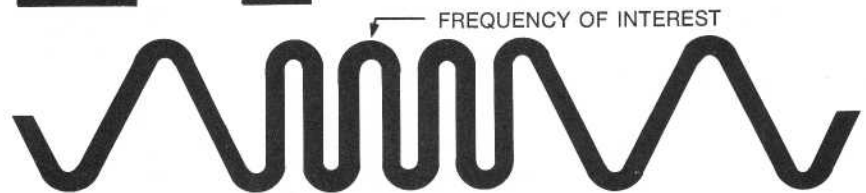
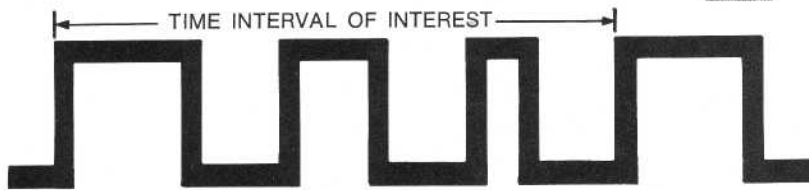
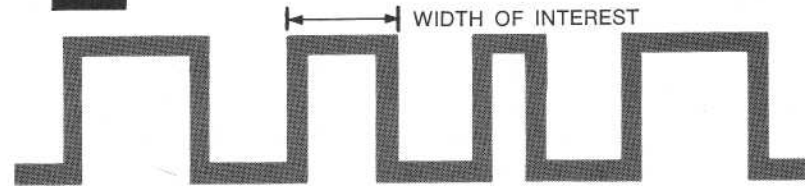
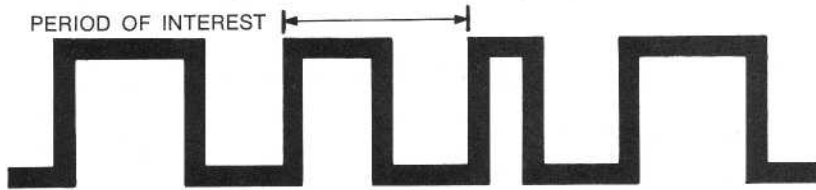

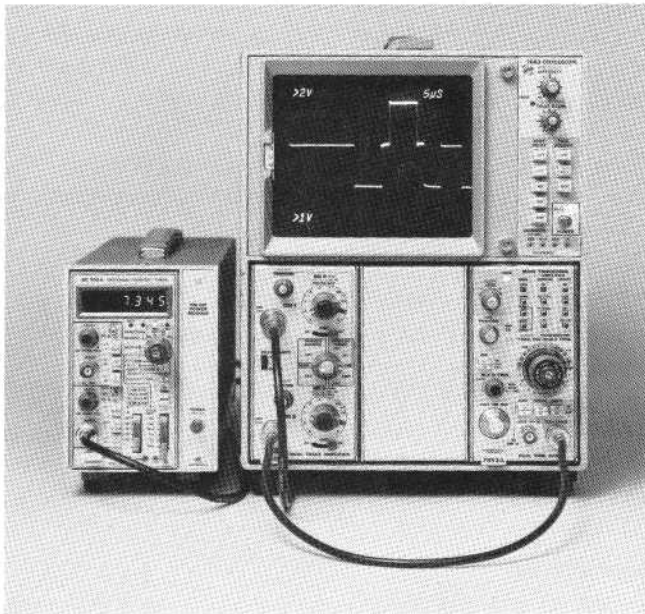

Fig. 1. A counter and oscilloscope set up to measure the width of the elevated pulse displayed on the oscilloscope crt.

In each example, the counter's trigger circuits cannot discriminate between the part of the waveform of interest and the part not of interest.

A few counters offer input gating that allows the input signal channel of the counter to be gated on and off with an external gate or control signal. This makes most of these difficult measurements possible; however, the appropriate gating signal is rarely conveniently available. A few counters offer Variable Hold-Off or Delay, which introduces a variable delay in the Time Interval mode, between when Channel A triggers and Channel B is permitted to trigger. This feature also makes some of these difficult measurements possible, but it can only be used in the Time Interval mode, and the approximate amount of delay required must be known.

Almost all of these difficult measurements can, of course, be made directly with an oscilloscope, but not with the same degree of accuracy a counter offers.

Counter and oscilloscope

A counter and an oscilloscope can be combined into a powerful measurement tool that can conveniently make these otherwise difficult or even impossible measurements. With the technique to be described, the counter can be made to measure any selected portion of the waveform displayed on the oscilloscope. Thus, the flexibility and visual verification offered by an oscilloscope is combined with the accuracy of a counter.

The technique involves summing or algebraically adding the portion of the waveform of interest with a pulse, so that the pulse creates a voltage pedestal upon which the portion of interest rides. With a portion of the waveform elevated, the counter's trigger threshold

VERTICAL SIGNAL OUTPUT

Mainframes	Bandwidth	Amplitude
7900 Series	140 MHz with 7A24 or 7A26 75 MHz with 7A18	500 mV/div into 1 M Ω 25 mV/div into 50 Ω
7700 Series	70 MHz with 7A24 or 7A26 55 MHz with 7A18	500 mV/div into 1 M Ω 25 mV/div into 50 Ω
7600 Series	75 MHz with 7A18	500 mV/div into 1 M Ω 25 mV/div into 50 Ω
7503/7504	55 MHz with 7A12	500 mV/div into 1 M Ω 25 mV/div into 50 Ω
7313/R7313	20 MHz with 7A18	500 mV/div into 1 M Ω 25 mV/div into 50 Ω
549	\geq 5 MHz with 1A1	1.5 V/div into 1 M Ω
544/546/547/ RM544/RM546/ RM547	15 MHz with 1A1	300 mV/div into 1 M Ω
535A/R535	5 MHz with 1A1	1.5 V/div into 1 M Ω
545A/B/ RM545A/B	\approx 20 MHz with 1A1	1.2 V/div into 1 M Ω

Fig. 2. TEKTRONIX oscilloscopes having delayed gate and vertical signal outputs suitable for this application.

(triggering level) can be set so that the counter triggers only on the desired portion.

If a Dual-Trace, Delayed Sweep Oscilloscope with a Vertical Signal Output and a Delayed Gate Output is used in conjunction with the counter, no other equipment is required. The Delayed Gate serves as the necessary pulse, the Dual-Trace Amplifier performs the summing function, and the Vertical Signal Output (a waveform identical to that displayed on the crt of the oscilloscope) is connected to the input of the counter. Figure 1 shows a 7603 Mainframe, 7A18 Dual-Trace Amplifier, 7B53A Delayed Sweep Time Base, and DC 505A Universal Counter/Timer in the described configuration. Figure 2 is a chart of TEKTRONIX Oscilloscopes with the necessary combination of features, and the bandwidth and amplitude of the Vertical Signal Outputs.

Making the measurement

The waveform, a portion of which is to be measured, is connected to Channel 1 vertical input of the oscilloscope and the controls are set for a stable display approximately two divisions in amplitude. The wide range of input amplitudes a laboratory oscilloscope can accept offers the added advantage of signal conditioning, amplifying or attenuating a waveform prior to being connected to the counter input.

With the waveform portion of interest displayed on-screen, the oscilloscope's Horizontal Mode switch is placed in the Intensified mode and the brightened portion of the trace is adjusted to intensify the portion of interest. The Delayed Gate Output, a pulse whose width and position relative to the oscilloscope trigger point is identical to the intensified portion of the trace,

is then connected to Channel 2 vertical input. The Vertical Mode switch is set to Channel 2 and the controls adjusted for a display two divisions in amplitude. Switching to the Algebraic Add mode, the two waveforms (the delayed gate and the input waveform) will now be summed and the combination will be approximately four divisions in amplitude as in Figure 1. If the delayed gate is positioned properly, the portion of the input waveform of interest will be elevated approximately two divisions.

The oscilloscope's Vertical Signal Output is now connected to the counter input and the counter's Trigger Level control is set so the counter triggers only on the elevated portion.

Setting the counter trigger level

If the counter has a DC Trigger Level Output, the trigger level can be set by monitoring this output with a DMM, setting it to the desired voltage level as read from the oscilloscope's crt. If the counter does not have a DC Trigger Level Output, the following technique will aid in setting the counter trigger level.

The amplitude of the voltage pedestal is lowered approximately 50% by adjusting the oscilloscope's Channel 2 Variable Volts Per Division control for a display about three divisions in amplitude. Adjusting the counter's Trigger Level control in the positive direction until the counter quits triggering, then in the negative direction until the counter just starts counting, or counts erratically, will set the counter to trigger on the positive-most portion of the input waveform. Now, returning the Channel 2 Volts per Division control to its original position (a four division display) will result in the counter triggering at the 50% point on the elevated portion of the waveform. This same technique can be used to set the counter's trigger level at other than the 50% point if desired.

Counter modes

Now let's consider making selected pulse or cycle measurements in the various counter modes available. Universal counters, as opposed to single function or frequency only counters, offer a variety of modes such as Period, Width, and Time Interval, as well as Frequency. Each mode requires that the width of the oscilloscope's delayed gate—the elevating pulse—be set a little differently.

Period

If a period measurement is to be made, the pedestal must be wide enough and so positioned in time that the entire period of interest is elevated as shown in Figure 3. In the Period mode, the counter will trigger at a point on the first positive or negative going slope, whichever is selected, and at the same point on the following slope of the same polarity.

Employing this technique, the Period mode can be used to measure frequency ($F = \frac{1}{T}$) when the frequency varies, or when it is a burst or chirp. In the Frequency mode a counter measures the average input frequency during the gate time. However, with this technique, frequency can be measured for as short a period as one cycle. The linearity of a swept frequency can even be measured cycle by cycle.

Width

If a width measurement is to be made, the set-up is the same as for a period measurement, except that the elevating pedestal must only be wide enough to elevate the width of interest as shown in Figure 4. The counter in the Width mode will measure the time between a point on the first slope of the selected polarity and the same point on the following slope of the opposite polarity.

Time interval

A counter that offers a Time Interval mode has two input channels and measures the time between when the first channel, Channel A, triggers and the second channel, Channel B, triggers. The slopes and trigger levels for each channel can be selected independently. In the Time Interval mode, Channel B is held off (not permitted to trigger) until A triggers; however, Channel B cannot normally be held off or prevented from triggering the next time the input waveform reaches its trigger level. With this technique, B can be held off as long as required to permit the counter to measure the time between any desired points on the input waveform. Unlike the Period and Width modes, the width of the pedestal or elevating pulse is adjusted to be slightly narrower than the time interval of interest. As shown in Figure 5, the A trigger level is set to trigger just as it was in the Width or Period modes, but the B trigger level is set below the level of the pedestal. Therefore, B will not trigger until the elevating pulse has returned to the lower level and the input waveform passes through the B trigger level. B can be held off or prevented from triggering as long as desired by increasing the width of the pedestal.

Small variations in pedestal width should cause no variation in counter reading if the pedestal is properly positioned. If the counter display varies directly with pedestal width, an erroneous reading is being obtained.

The two input channels can be connected to a single waveform or to two separate waveforms, and a portion of either waveform can be selected and elevated. A portion of each of two waveforms can also be elevated and thereby selected, however, this would require an additional pulse and summing amplifier.

Frequency

Making frequency measurements directly is not practical using this technique because the counter's gate and

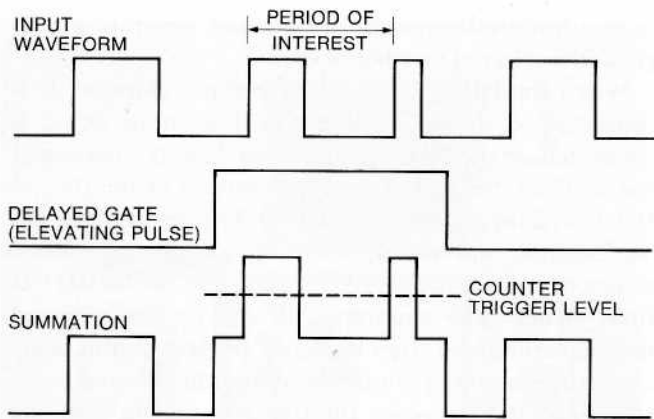

Fig. 3. In period measurement, delayed gate width must be wide enough to elevate entire period of interest.

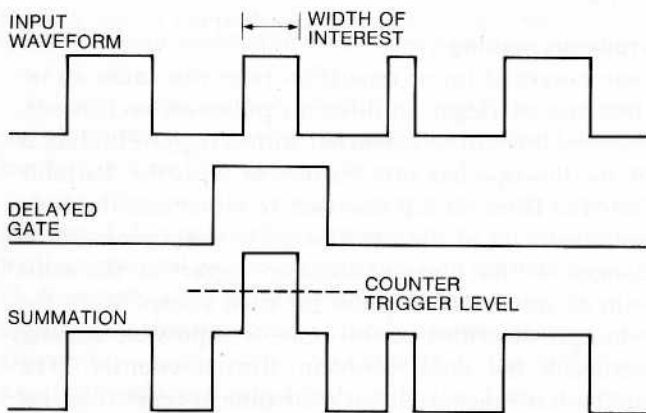

Fig. 4. Delayed gate set properly for width measurement.

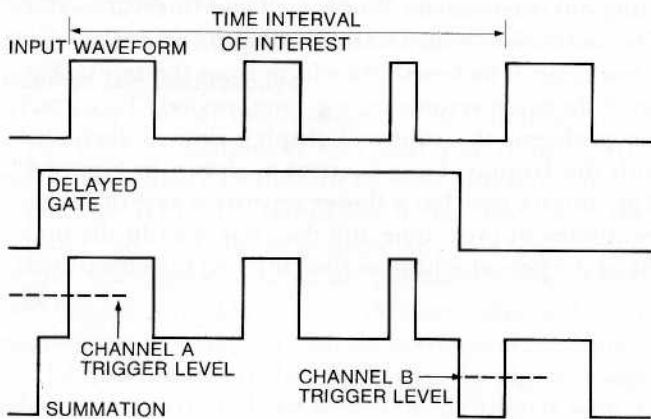

Fig. 5. For time interval measurements, delayed gate is set slightly shorter in duration than time interval to be measured.

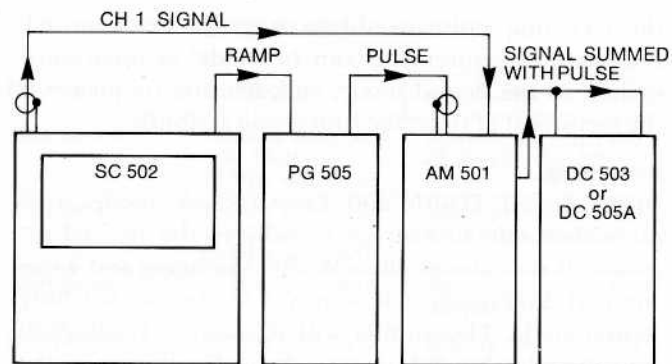

Fig. 6. TM 500 Series configuration for making gated counter measurements with a non-delayed sweep oscilloscope. The AM 501 performs the summing function normally provided by the oscilloscope.

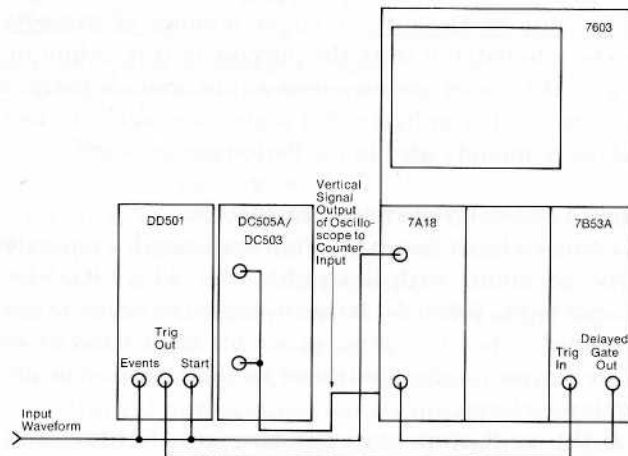

Fig. 7. The DD 501 Digital Delay simplifies trigger selection when delaying the triggering of the counter for several pulses or cycles.

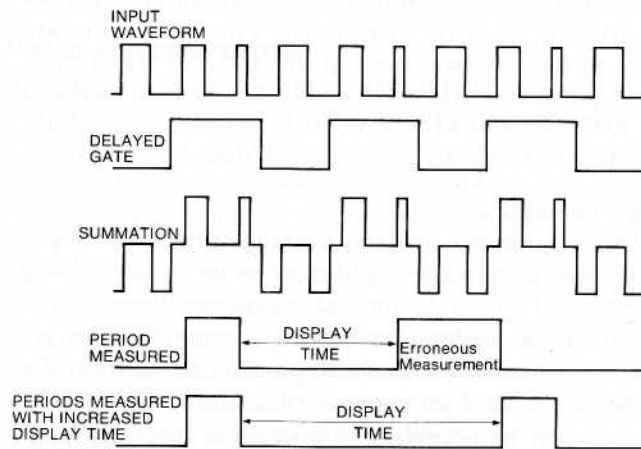

Fig. 8. Erroneous readings can occur at some display time settings. If the counter readout is erratic or too large a number, increase the display time with the Display Time Control.

the elevating pulse would have to be synchronized. Frequency measurements can be made, as mentioned earlier, in the Period mode, and, because frequency is the reciprocal of time, the conversion is simple.

Averaging

In the Period, Width, and Time Interval modes, it is often desirable to average to achieve the desired accuracy. If the counter offers Width Averaging and Time Interval Averaging, it is simply a matter of switching to that mode. The counter will accumulate readings in decade multiples and average them. No change in the procedure for a single Time Interval or Width measurement is necessary. For period averaging, however, an alteration to the technique is necessary. In period averaging, the number of periods to be averaged must all be elevated. To average 10 periods, 10 or more successive or continuous periods must be elevated. To average 100 periods, 100 or more successive or continuous periods must be elevated. A larger number of averages can be selected, but since the purpose of this technique is to make a selective measurement of a small portion of a signal, it is unlikely that higher averaging factors will be commonly used in the Period mode.

Using a non-delayed sweep oscilloscope

If a Non-Delayed Sweep Oscilloscope is used, a separate pulse generator with delay, like the TEKTRONIX PG 505 or PG 508, must be incorporated to generate the necessary pulse. The pulse generator must have delay so its output can be positioned in time relative to the input waveform.

If the oscilloscope does not have an Algebraic Add mode, a separate amplifier like the AM 501 can be incorporated to serve this function.

The TM 500 product line provides an ideal solution to the problem. Figure 6 is a diagram showing the SC 502 Non-Delaying Sweep Oscilloscope, PG 505 Pulse Generator, AM 501 Amplifier, and either the DC 503 or DC 505A Universal Counter/Timer with the appropriate interconnections in the TM 500 Mainframe. This particular system is usable from dc to between 50 kHz and 100 kHz, limited by summing amplifier bandwidth and pulse generator rise times.

Digital delay

When it is necessary to delay the triggering of the counter for a large number of pulses or cycles, it can become impractical due to the limited resolution offered by the crt of an oscilloscope, even with a magnifier. For example, it would be almost impossible to position the pulse or pedestal on the one thousandth input pulse to measure its period, width, or time interval. Even with a times ten magnifier, there would be ten input pulses or cycles per division on the crt. The DD 501 Digital Delay solves this problem. It can delay by up

to one hundred thousand events and generate a trigger at the selected number of events.

When the DD 501 is used with this technique, it is connected as shown in Figure 7. The input signal is connected to the DD 501 Start and Events inputs and the input of the oscilloscope. The output of the Digital Delay is connected to the External Trigger input of the oscilloscope, and the appropriate number of events, pulses, or cycles to be delayed is dialed up on the DD 501 front panel. The counter is driven by the summed pedestal and signal from the scope vertical output or by a separate summing amplifier. When the selected number of events takes place, the DD 501 puts out a trigger that triggers the scope and the delayed gate. A faster oscilloscope sweep speed can now be used, which offers enough resolution to position the elevating pulse.

If it is necessary to delay by time, the counter's time base output can be connected to the DD 501 input. The counter's time base acts as a clock that the DD 501 counts.

Erroneous reading

Some ranges of input repetition rates can cause an oscilloscope to trigger on different pulses on each sweep, however, this can be corrected with Trigger Hold-off if the oscilloscope has this feature, or with the Variable Time Per Division if it does not. In either case the basic repetition rate of the oscilloscope's sweep generator is changed so that the oscilloscope triggers at the same point or on the same pulse for each sweep. With the technique described in this note, it is possible to have essentially the same problem with a counter. The counter has a measurement cycle time or repetition rate which is determined by the length of time it takes to make the measurement, plus the display time. As shown in the period measurement in Figure 8, if the counter's measurement cycle time results in the display time ending in the middle of the period to be measured, an erroneous period measurement results. And the same thing can occur in the Width or Time Interval modes. The indication is an erratic reading or a reading that is too large. The fourth waveform from the top in Figure 8 shows an erroneous, too long, period. To correct the problem, the counter's display time is increased with the Display Time Control as shown in Figure 8. The counter now has a slower repetition rate or longer measurement cycle time and does not reset in the middle of the period, width, or time interval to be measured.



Ralph Livermore

Testing three-terminal regulators with a curve tracer

The increasing cost of on-board three-terminal regulators has created a need for a fast and easy means of testing these devices. Many of you already possess that capability and may not realize it.

The Tektronix 577-D1 Storage Curve Tracer and 178 Linear IC Test Fixture provide the basic capability. All you need to add is the Three-Terminal Regulator Test Unit—a plug-in accessory for the 178—plus a socket adapter for your particular device, and you're in business. It's an ideal solution for short run inspection, circuit design, or device characterization.

The Regulator Test Unit comes in two similar models—one wired for negative regulator devices and one for positive units. Each slides into the 178, which is itself a slide-in module for the 577. A snap-on escutcheon plate customizes the 178 function switch to either positive or negative test units.

Functionally, the 577 Mainframe supplies the display and its controls, primary power supply, and a step generator that serves as a variable load. The 178 further

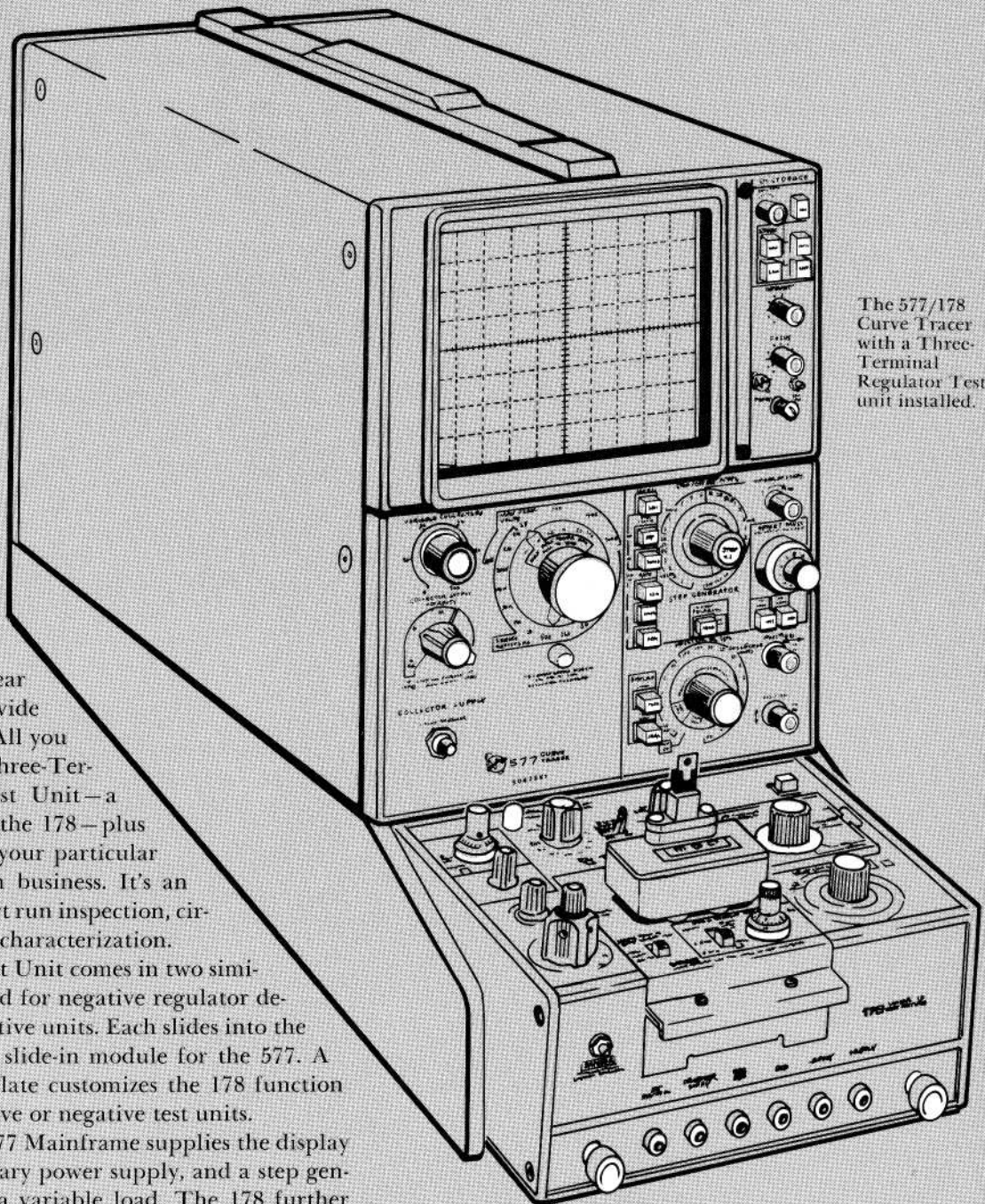

The 577/178 Curve Tracer with a Three-Terminal Regulator Test unit installed.

regulates the supply voltages and provides the function selector switch, which sets up the internal circuits for the appropriate tests. The 178 also has provision to sweep the input supply voltages at a selected rate and amplitude for line regulation and other tests.

Four basic tests on three-terminal regulators can be performed on the 577/178: load regulation, line regulation, quiescent or common current, and dropout voltage. A fifth test, ripple rejection, can also be performed, depending on how it is specified. The devices can be tested over an input range of 0 to 60 volts, with load currents up to 2 amperes (pulsed).

Load regulation

Load regulation is the change in regulator output voltage over the specified range of load current, with provision made to keep chip temperature constant.

This test is done on the curve tracer using the step generator as a current sink or variable load. The step generator is operated in the pulse mode to provide a load that is active for only a small part of the duty cycle, thus keeping chip dissipation low and possible temperature rise small.

The display in Figure 1 shows the change in output voltage (vertical axis) as the load current is stepped over the specified range (horizontal axis). In Figure 2 the vertical sensitivity has been increased to improve the resolution of the measurement. The Output Voltage Comparison Dial is set so the trace crosses the bottom graticule line precisely at the rated load current point. The change in output voltage is then easily determined by multiplying the VERT UNITS/DIV setting by the indicated change in output voltage on the vertical axis.

Line regulation

Another important specification we need to check is line regulation—the change in regulator output voltage over a specified range of input voltage—with provisions made to keep the chip temperature constant.

The curve tracer provides the necessary test conditions by adding a swept voltage to the input voltage supply, while providing a constant, short duty-cycle load for the output.

In the display in Figure 3, the vertical axis represents regulator output voltage deviation from the comparison voltage, and the horizontal axis represents regulator input voltage.

Line regulation characteristics at different values of load current can be checked by setting the step generator to step through the desired range of load currents as in Figure 3.

Quiescent or common current

A third characteristic often of interest to the circuit designer is the current used by the regulator for its in-

ternal functioning. It is called quiescent or common current. The regulator test unit uses a common-terminal supply to produce an artificial ground through which the device-under-test quiescent current is measured.

The curve tracer can display quiescent current under three different conditions: steady state, with constant load and line (input) voltage change, and with constant input voltage and changes in the load. Changes in input voltage are provided by the sweep generator on the 178 Linear IC Test Fixture. Load changes are produced by using the 577 step generator in the current-sinking mode.

The display in Figure 4 plots quiescent current on the vertical axis, versus load current on the horizontal.

Dropout voltage test

The fourth characteristic of interest that can be checked with the 577 Curve Tracer is dropout voltage. The dropout voltage test is similar to the line regulation test except, in this instance, we are concerned with the minimum input voltage at which the regulator no longer regulates. Figure 5 is an illustration of the dropout voltage test. The input-output voltage differential at which the circuit ceases to regulate is dependent upon load current and junction temperature, and is typically two volts.

Ripple rejection test

Ripple rejection tests can also be performed on the curve tracer as displayed in Figure 6. The supply voltage is swept at a frequency just below 120 Hz to produce the display. Each trace represents a different load current as presented by the step generator. Storage is a necessity in achieving this display since it takes about a second to produce.

Conclusion

The 577-D1 Storage Curve Tracer with a 178 Linear IC Test Fixture and Three-Terminal Regulator Test Unit provides a low-cost, versatile means of performing incoming inspection tests, circuit design, or device characterization of three-terminal regulators. Most of the specified tests can be performed. The 577 also serves as a valuable analytical tool to evaluate those devices rejected by highly automated incoming inspection systems, and to analyze performance under operating conditions other than those specified on the spec sheet. 

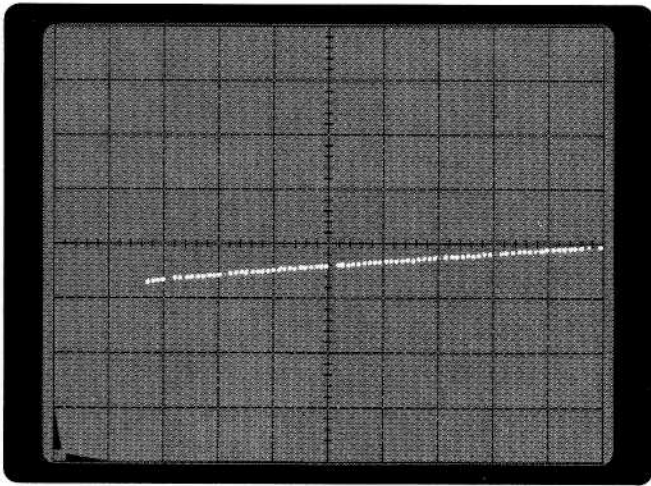

Fig. 1. Load regulation test. Output voltage displayed vertically at 50 mV/div, offset to +5V; load current displayed horizontally at 20 mA/div.

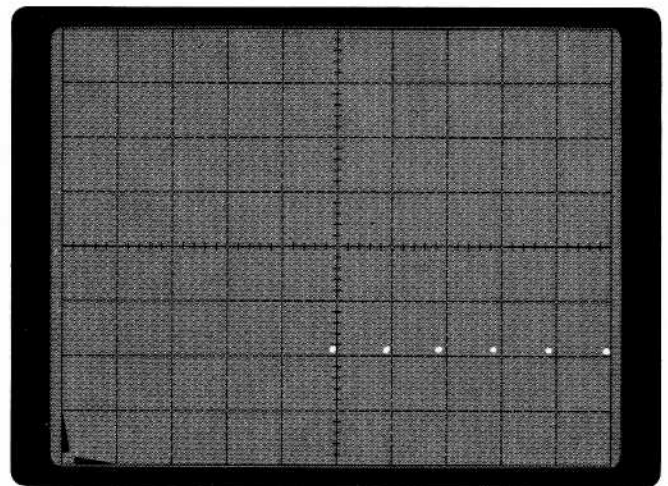

Fig. 4. Quiescent current test. Quiescent current displayed vertically at 2 mA/div, zero current at center-screen; load current displayed horizontally at 100 mA/div.

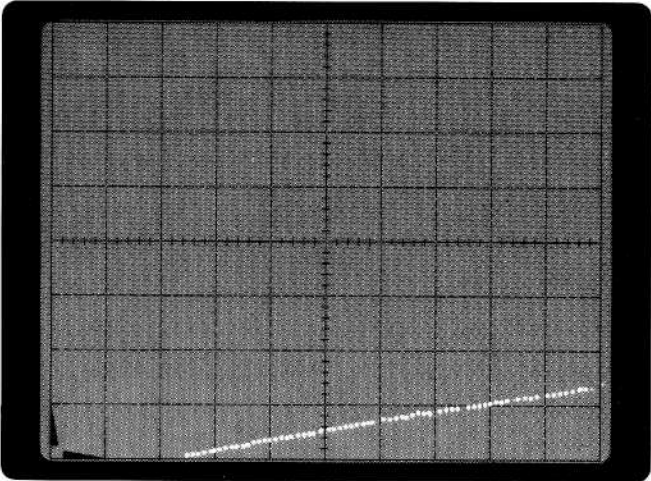

Fig. 2. Same measurement as Fig. 1. except vertical sensitivity increased to improve resolution, and trace moved to bottom of screen for easier reading.

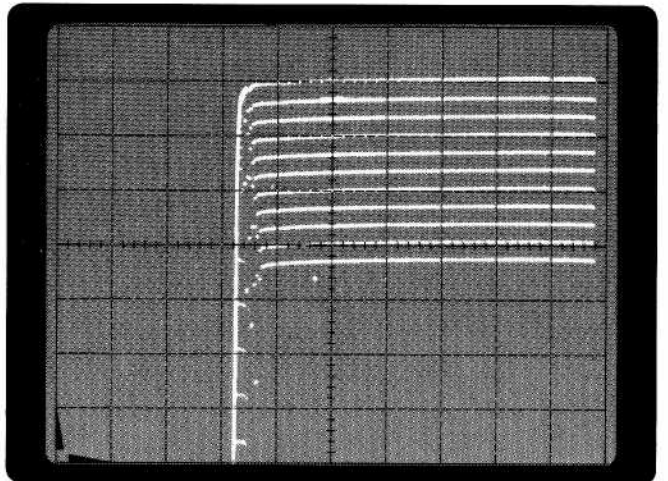

Fig. 5. Dropout voltage test. Output voltage displayed vertically at 10 mV/div, top trace is offset to 5V; input voltage displayed horizontally at 2V/div.

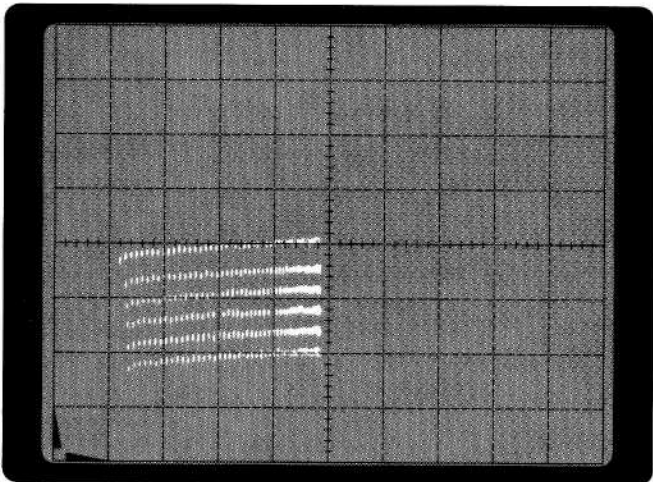

Fig. 3. Line regulation test. Output voltage displayed vertically at 5 mV/div; input voltage displayed horizontally at 5V/div, load currents are 100 mA/step.

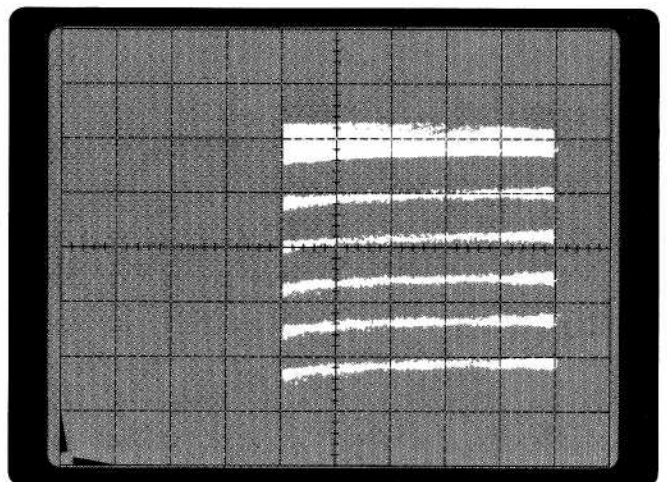

Fig. 6. Ripple rejection test. Output voltage displayed vertically at 5 mV/div; input voltage displayed horizontally at 2V/div; load currents are 100 mA/step. Rejection is about 76 dB.



Charles Phillips

Servicescope

Tektronix products get dirty, too!



Part II—Dry cleaning

In Part I of this article we described the tools and techniques used to give your Tektronix instrument a bath, or perhaps "shower" would be a more appropriate term. There are times when the customer needs quick turn around on an instrument and can't tolerate the 24-hour drying time needed for a wet wash. In this instance, dry cleaning may serve as a reasonable alternative.

The wash booth makes a convenient place to perform the dry cleaning operation. With the side and bottom panels removed, compressed air and a small paint brush will remove most of the interior dust, unless the instrument has been in a greasy environment.

To clean the front panel you should reinstall the side covers and lightly spray the front panel only, using the 5% Kelite solution and rinsing with water. Be careful not to get excess water in the instrument. Just a little spray applied on an angle works best.



Use a toothbrush and detergent to clean the knobs and connectors, and rinse with warm water. The side covers can be removed and, along with the bottom panel, be washed separately after removing the instrument from the booth. They should be placed in the oven to dry. Compressed air is used to remove as much water as practicable from the front panel area, and the instrument is then placed in the oven for 15 to 20 minutes, or until you're ready to work on it.

The graticule and graticule cover may be cleaned as described in Part I. A word of caution regarding the use of glass cleaner—some leave a static charge on the graticule, which will distort the crt trace until it bleeds off. Soap and water is the best solution.

Air filters can be cleaned easily with detergent and hot water. A cleansing powder, such as Ajax, sprinkled on a wet filter and allowed to soak a minute or two, will help on extra greasy ones. We recommend not using oil or filter coat on any filters as there is the possibility of oil getting inside the instrument.

Cleansing cam switches

Unless you are having problems with the cam switches in the instrument, we do not recommend removing the switch covers during the cleaning procedure. You should also take care not to spray detergent into the switches.

If a cam switch needs cleaning, this can best be accomplished by removing the switch cover and spraying the switch with a 5% solution of Kelite spray white with an equal amount of ammonia (non-sudsing, non-soapy type). The switch should then be thoroughly rinsed with soft or distilled water. The switch contacts should then be sprayed with isopropyl alcohol, let set for 60 seconds, and blown out with compressed air. Occasionally operate the switch in all positions while the alcohol is still on the contact area, and while blowing out the instrument. Oven dry in the usual manner.

Cam switches need no lubrication as the switch pads are designed to operate dry for the life of the instrument.

Conclusion

Whether you wet wash or dry clean an instrument will be determined by how dirty the instrument is, and the time available to do the job. Solid state instruments can be washed as easily and safely as vacuum tube types. Precautions against spraying detergent and water directly on power transformers and covered cam switches should be diligently observed. Cleaning agents such as

trichlorethylene, Freon, and others containing halogens, should not be used. They can damage aluminum electrolytic capacitors and some printed circuit board materials used in critical applications.

It takes valuable time to properly clean an instrument. However, the improvement in maintainability and the increase in user satisfaction makes the investment a worthwhile one. 

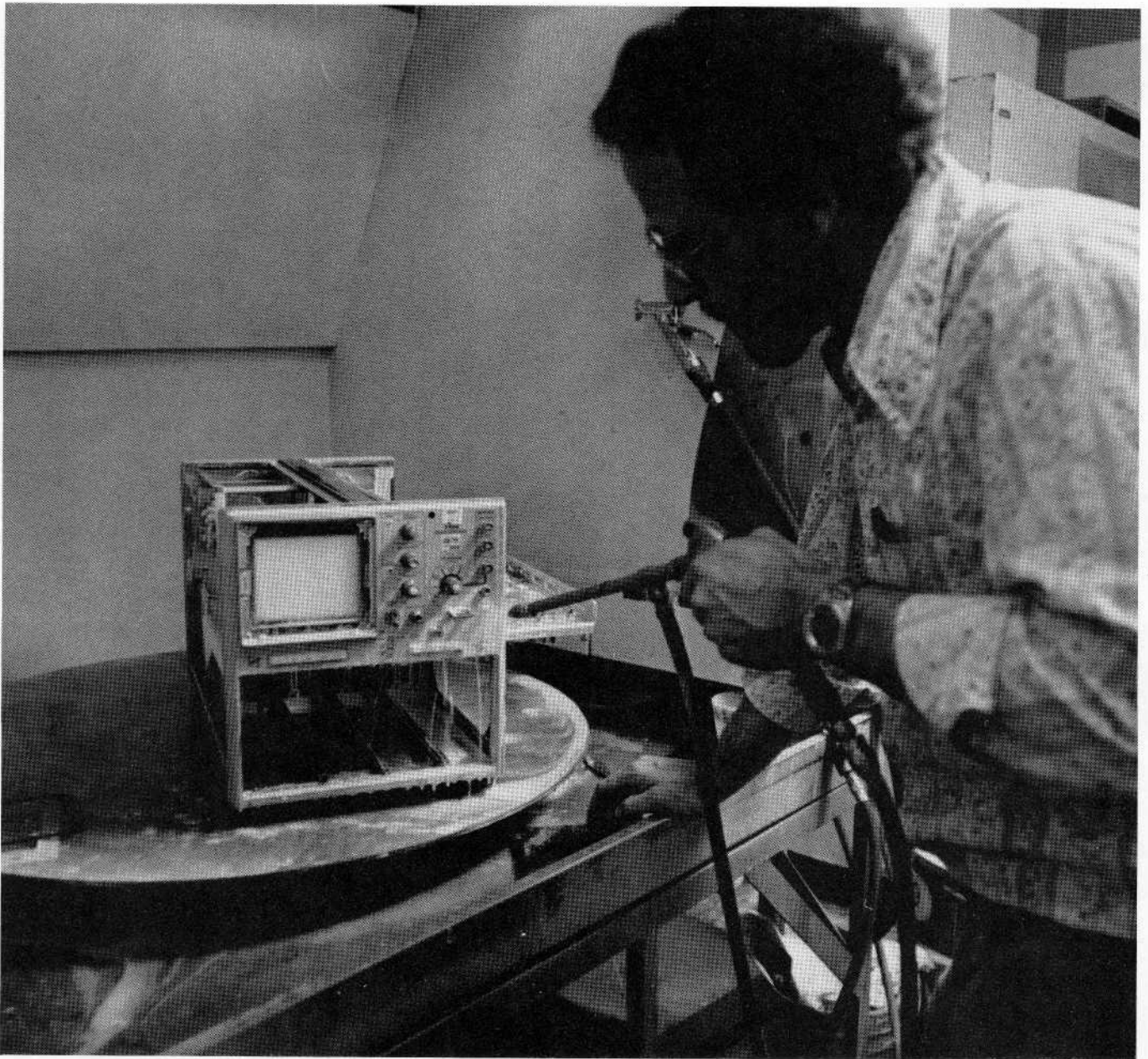

Fig. 1. Dave Phillips, Factory Service Center, washes a 7000-Series Oscilloscope.

Customer maintenance training classes for '77

All classes will be conducted at Beaverton, Oregon. There is no fee for classes except as noted.

All maintenance classes teach operation, signal flow, calibration, trouble-shooting and repair of the representative instrument. A combination of lecture and lab sessions are the usual format for maintenance training. Any prestudy literature besides maintenance manuals will be mailed directly to you.

7704A/7904/7633

The 7000 series classes are a combination of the 7704A/7904/7633 oscilloscopes. The prerequisite for the 7904/7633 class is training on the 7704A. Class duration is two weeks, first week devoted to 7704A, second week devoted to 7904/7633. Plug-ins taught are representative of the most frequently purchased units with these main frames.

Class dates: June 13-24, 1977
Aug. 8-19, 1977
Oct. 17-28, 1977
Dec. 5-16, 1977

465/475

The 465/475 oscilloscopes maintenance class is taught to the component level of troubleshooting and repair. The student is encouraged to study the circuit description portion of the respective manual. Class duration is one week.

Class Dates: June 27-July 1, 1977
Aug. 22-26, 1977
Oct. 31-Nov. 4, 1977

5100/5400

The 5100/5400 oscilloscopes are new products on the 1977 customer training schedule. Representative plug-ins are selected for these products. Class duration is one week.

Class dates: July 11-15, 1977
Nov. 7-11, 1977

Logic Analyzers

The 7D01/DF-1 logic analyzer is a new product on the 1977 customer training schedule. The prospective student is encouraged to study the circuit description in the 7D01/DF manual. Class duration is one week.

Class date: Sept. 12-16, 1977

TM503/DC503/DM502

TG501/PG501/FG501

The TM500 products selected for instruction represent each of the major categories in the Test and Measurement area. Class duration is one week.

Class dates: June 6-10, 1977
Aug. 1-5, 1977
Oct. 10-14, 1977

WDI—R7912/1350

The student must have operational knowledge of the 7704A series oscilloscope; he also must have satisfactorily completed study of the Audio Circuit description training program on the R7912. This package (062-2708-00) is available for \$175.00 through the local Tektronix field office; it should be ordered at least 60 days prior to class participation as the subject material is quite lengthy. Class duration is one week. A class fee of \$700 per student is charged for this training.

Class dates: July 11-15, 1977
Oct. 3-7, 1977

DPO—P7001/CP1151

No customer maintenance classes are scheduled for 1977. An audio circuit description training package is available for \$185.00 through your local Tektronix field office. Part number (062-2707-00)

4051/4631

The 4051 intelligent terminal is a new product on the 1977 customer training schedule. Understanding of microprocessor is necessary for full appreciation of class content. Class duration is two weeks.

Class Dates: June 20-July 1, 1977
Dec. 5-16, 1977

4010/4014/4631

The 4010/4012/4014/4006 graphic display terminal class is taught to board level maintenance; greater depth is taught when signal flow concepts are necessary. Class duration is one week.

Class Dates: June 6-10, 1977
Oct. 3-7, 1977
Nov. 7-11, 1977

4081/4905/4641

The 4081 intelligent terminal system is a new product on the 1977 customer training schedule. Understanding of microcomputer and microprocessor theory is necessary for full appreciation of class content. Class duration is two weeks.

Class Dates: July 18-29, 1977
Sept. 26-Oct. 7, 1977

A-3549

TEKTRONIX, INC.
P.O. BOX 500
BEAVERTON, OR. 97005

**BULK RATE
U.S. POSTAGE
PAID
Tektronix, Inc.**